

2x 3MP

2x 5MP

2x 8MP

Up to 10-Year Warranty

Alta H6A Dual Head camera

Double the coverage in the cloud



Improve coverage in difficult spaces using the Avigilon Alta H6A Dual Head camera. With adjustable varifocal lenses and IR illumination, this single camera performs the functions of two, significantly minimizing blind spots. Real-time video analytics aid in incident detection.



Compliant with NDA 2019 Section 889

Do more with less



Get the functionality of two cameras in one powerful dual head form factor. Reduce the total cost of ownership with a single cable run and license while streamlining initial setup.

AI-powered video analytics



Stay on top of what's happening at your site with built-in video analytics and intelligent insights. Show occupancy counting, people flow using heatmaps and save time with Smart Search.

Trusted and secure



Avigilon Alta video security solutions are built on a cyber-secure platform with ISO/IEC 27001 certification. Safeguard your data with a comprehensive end-to-end security system.

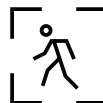

Custom field of view & zoom

Achieve the ideal perspective with the camera's varifocal lenses, allowing you to customize the field of view. Zoom into a scene for a closer look while preserving evidentiary details.



Advanced audio analytics

Expand your real-time awareness with audio alerts for gunshots, breaking glass, screeching tires, and more. You can also record audio evidence if needed with the optional recording.



24/7 Connected convenience

Easily view and manage your cameras anytime through a cloud-native platform. Automatic firmware updates keep your devices up-to-date, adding new features and reducing maintenance.

To learn more, visit avigilon.com/security-cameras/h6a-dual-head



Specifications

Image Performance		2 x 3.0 MP	2 x 5.0 MP	2 x 8.0 MP
Image Sensor		1/2.8" progressive scan CMOS		
Imaging Area (H x V)		5.18 mm x 3.89 mm 0.204" x 0.153"		
Aspect Ratio		4:3	16:9	
Dynamic Range	WDR Off	Up to 80 dB		
	WDR On	Up to 105 dB (measured according to IEC 62676 Part 5)		
	WDR On	Up to 120 dB		
Max Frame Rate		30fps (available in Advanced mode only)		
Streaming Resolutions	Maximum	2048 x 1536** 15fps @ 3.0Mbps	2592 x 1944** 15fps @ 3.0Mbps	3840 x 2160** 15fps @ 6.0Mbps
	High	2048 x 1536** 15fps @ 1.5Mbps	2592 x 1944** 15fps @ 1.5Mbps	3840 x 2160** 15fps @ 3.0Mbps
	Medium	1600 x 1200 15fps @750Kbps	1600 x 1200 15fps @750Kbps	1080p (1920 x 1080) 15fps @ 1.5Mbps
	Low	640 x 480 15fps @400Kbps	640 x 480 10fps @400Kbps	640 x 360 5fps @700Kbps

** These cameras only provide three resolutions: Maximum, Medium, and Low. When selecting High resolution, the camera defaults to using the Maximum settings.



Lens and IR Illumination		
Lens focal length (EFL)		Wide: 3.24 mm Tele 7.33 mm
IR Illumination (high power 850 nm LEDs)		30 m
Minimum Illumination Without IR	2x 3 MP, 2x 5 MP	Monochrome: 0.lux in monochrome mode Color: 0.005 lux in monochrome mode; 0.02 lux in color mode
	2x 8 MP	Monochrome: 0 lux in monochrome mode Color: 0.005 lux in monochrome mode; 0.05 lux in color mode
Horizontal Angle of View	2x 3 MP, 2x 3 MP	(4:3) Wide: 96°, Tele: 40°
	2x 8 MP	(16:9) Wide: 104°, Tele: 43°
Vertical Angle of View	2x 3 MP, 2x 5 MP	(4:3) Wide: 70°, Tele: 30°
	2x 8 MP	(16:9) Wide: 55°, Tele: 24°
Max Aperture		F1.6
Lens Control		Remote Zoom and Focus, Autofocus, IR Cut Filter

Image Control	
Image Compression Method	H.264 HDSM SmartCodec
Streaming	Multi-stream H.264, HLS
Electronic Shutter Control	Automatic
Day/Night Control	Automatic, Color, Monochrome
Flicker Control	50 Hz, 60 Hz
Iris Control	No Iris Control
White Balance	Automatic
Backlight Compensation	Automatic
Image Rotation	0°, 90°, 180°, 270°
Privacy Zones	Up to 64 zones



Network	
Network	100BASE-TX
Cabling Type	CAT5e
Connector	RJ-45
ONVIF*	ONVIF® compliance; Profile S, T, M, and G (www.onvif.org)
Security	Password protection, HTTPS encryption
Protocols	IPv4, HTTP, HTTPS, SOAP, DNS, NTP, RTSP, RTCP, RTP, TCP, UDP, IGMPv3, ICMP, DHCP, Zeroconf, HSTS
Streaming Protocols	WebRTC, RTP/RTSP/UDP, RTP/RTSP/TCP, RTP/RTSP/HTTP/TCP, RTP/RTSP/HTTPS/TCP
Platform compatibility	Avigilon Alta Aware, Avigilon Unity ACC*, 3rd party VMS*

* Requires camera to be running in Avigilon Unity mode

Auxiliary I/O	
Audio Input/Output	Line level audio I/O
Audio Compression Method	G.711 PCM 8 kHz, Opus
Microphone	Built-in microphone

¹ Not currently supported

Mechanical		Direct Surface Mount	Surface Mount with Junction Box	Pendant Mount with NPT Adapter
Dimensions (L x W x H)	Camera Assembly	218 x 125 x 89 mm	250 x 157 x 126 mm	236 x 143 x 151 mm
	Accessory Only	N/A	250 x 157 x 50 mm	236 x 143 x 75 mm
Camera Weight		1.42 Kg	2.43 Kg	1.74 Kg
Dome Bubble		Polycarbonate		
Body		Polycarbonate and aluminum		
Finish		Cast, powder coat grey (Pantone 427C)		
Adjustment Range		Pan: 180°, Azimuth: 360°, Tilt: 30° - 95° tilt (recommended), 10° - 95° tilt (maximum)		



Electrical		
Power Consumption		25.4W
Power Source	PoE	IEEE 802.3af Class 3
	PoE+	IEEE 802.3at Class 4
RTC Backup Battery		3V manganese lithium
Memory		4GB RAM 4GB Flash

Environmental		
Startup and Operating Temperatures		-40 °C to +65 °C (-40 °F to 149 °F) with IEEE 802.3at Class 4 (25.5W PoE+) with ambient convection -30 °C to +65 °C (-22 °F to 149 °F) with IEEE 802.3af Class 3 (13W PoE) with ambient convection
IR Illuminator Behavior	PoE	The IR illuminator operates at 40% power regardless of temperature
	PoE+	The IR illuminator operates at 50% power if the temperature is below -30°C (-22°F) or above 60 °C (140 °F)
Absolute Maximum Temperature		74°C (165°F) per NEMA TS2 (Temp.) para 2.2.7.2 - 2.2.7.7
Storage Temperature		-10°C to +70°C (14°F to 158°F)
Humidity		0 - 95% non-condensing



Certifications	
Certifications/Directives	UL, cUL, CE, ROHS, RCM, UKCA, NOM, KC, BIS
Safety	UL 62368-1, CSA 62368-1, IEC/EN 62368-1 IEC 62471
Environmental	IEC 60529 IP66, IP67, IP68 (1.8m depth for 1 hour) ISO 20653 IPX9K IEC/EN 62262 Impact (IK10) NEMA 4X IEC 60068-2-6 Product Vibration IEC 60068-2-27 Product Shock NEMA TS2 paragraph 2.2.7-2.2.9
Electromagnetic Emissions	FCC Part 15 Subpart B (Class B) ICES-003 (Class B) EN 55032 (Class B) EN 61000-6-3 EN 61000-3-2 EN 61000-3-3
Electromagnetic Immunity	EN 55035 EN 61000-6-1 EN 50121-4 EN 50130-4
Warranty	Limited 10-year Warranty



Analytics specifications

Detected attributes	
Vehicle:	<p>Vehicle type:</p> <ul style="list-style-type: none"> • 2-wheeled (bicycle, motorcycle) • Small vehicle (sedan, etc.) • Large Vehicle (5 doors vehicle) • Unknown (Unclassified vehicles) <p>Vehicle color:</p> <ul style="list-style-type: none"> • Only this color • Ignore this color <p>License Plate Recognition *</p>
Person:	<ul style="list-style-type: none"> • Fall detection (Search only) • Accessories: <ul style="list-style-type: none"> • With/Without bag • Bag Held/Dropped/Picked up (Search only) • Clothing Color: <ul style="list-style-type: none"> • Only this color • Ignore this color • Upper body clothing color • Lower body clothing color <p>Face detection **: </p> <ul style="list-style-type: none"> • All faces • Select watchlists

* Not currently supported.

** Requires additional license. Check national and local legislation for guidance on the use of face search and face watchlists.



Supported analytic rules	
Anomaly	<p>Rule triggered on detected anomalies based on:</p> <ul style="list-style-type: none"> • Unusual time of day • Unusual location • Unusual velocity
Appearance	<p>People:</p> <ul style="list-style-type: none"> • Rule triggered when an object of the selected type and attributes appears in the region of interest. <p>Vehicles:</p> <ul style="list-style-type: none"> • Appearance: type, color, license plate, or similarity (against a reference image).
Loitering	<p>Rule triggered when an object of the selected type and attributes loiters in the selected area for the selected period of time.</p>
Line crossing	<p>Crossing a virtual line set up for:</p> <ul style="list-style-type: none"> • Vehicle: type, color, license plate • Person: with/without bag, top and bottom clothing color or similarity (reference image); Facial recognition
Counts	<p>Rule triggered when the count of objects of the selected type either exceeds or is less than the selected threshold.</p>
Line Crossing Count	<p>Rule triggered when the specific number of objects of the selected type either cross a line to enter or leave an area.</p>
Sound	<p>Rule triggered when sounds of specified types is detected.</p>
Access Control ²	<p>When integrated with suitable access control systems, create rules for access events.</p>
Point-of-sale ²	<p>Search/rule set up based on text field and price.</p>
System rules	<p>Camera issue (any camera):</p> <ul style="list-style-type: none"> • Camera connection failure (timeout after minutes) • Unmet retention period (days) <p>Camera issue (Avigilon Alta cameras)</p> <ul style="list-style-type: none"> • Image health: monitors changes to the image over time based on reference images • SD card failure • Analytics failure • Camera top cover removed • Camera in recovery mode • Camera not storing <p>System issues</p>



Supported analytic rules

- Cloud Connector connection issues
- Software issues
- Disk failures
- Disk missing
- Disk space
- Audit log storage limit
- Cloud connection
- Access control connection

² Requires additional license.

Supported audio events

Audio Events³

- Glass breaking
- Loud noise
- Gun shot
- Screaming
- Smoke alarm
- Car alarm
- Ultrasound panic alarm
- Dog bark
- Tire screeching

³ Additional license required for audio recording.



Outline Dimensions

Dual Head Camera with Provided Surface Mount (H6ADH-DO1-IR)

[X.X]	INCHES
X	MM

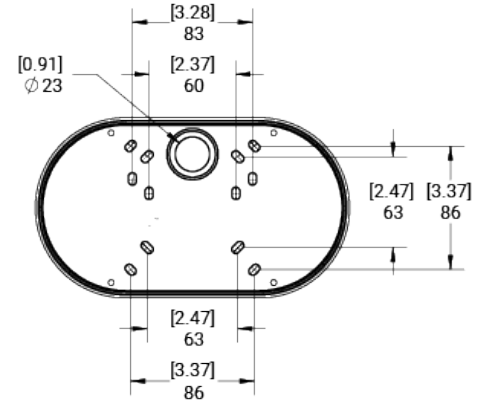
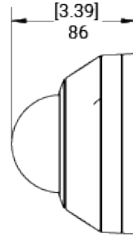
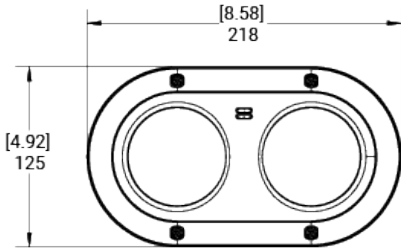

Dual Head Camera with NPT Adapter (H6ADH-DO1-IR Camera + NPTA-1201)

[X.X]	INCHES
X	MM

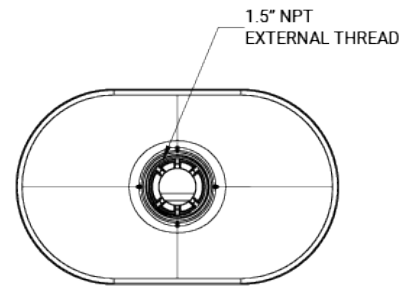
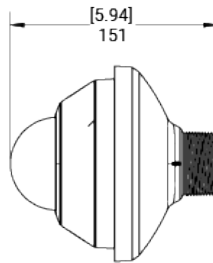
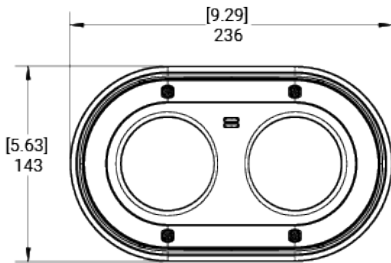

Dual Head Camera with Junction Box Mount (H6ADH-DO1-IR Camera + JBOX-1201)

[X.X]	INCHES
X	MM

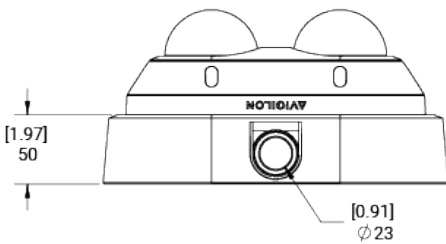
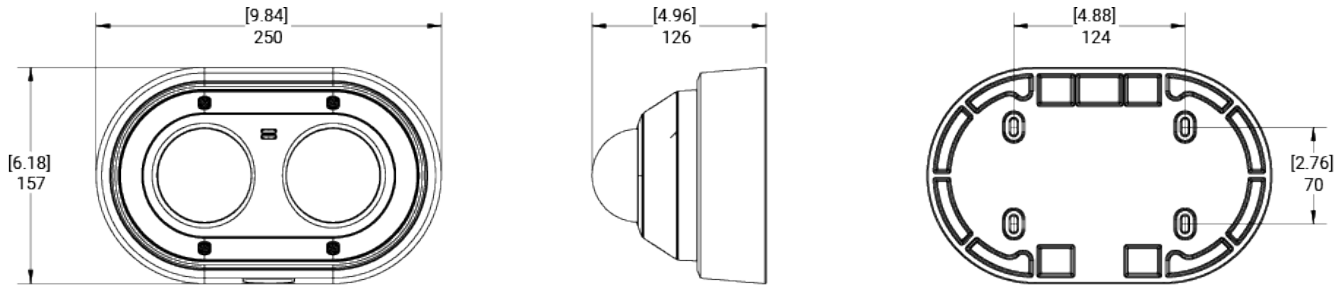

H6A Dual Head Camera with Pendant Mount (H6ADH-DO1-IR Camera + NPTA-1201 + WLMT-1021)

[X.X]	INCHES
X	MM

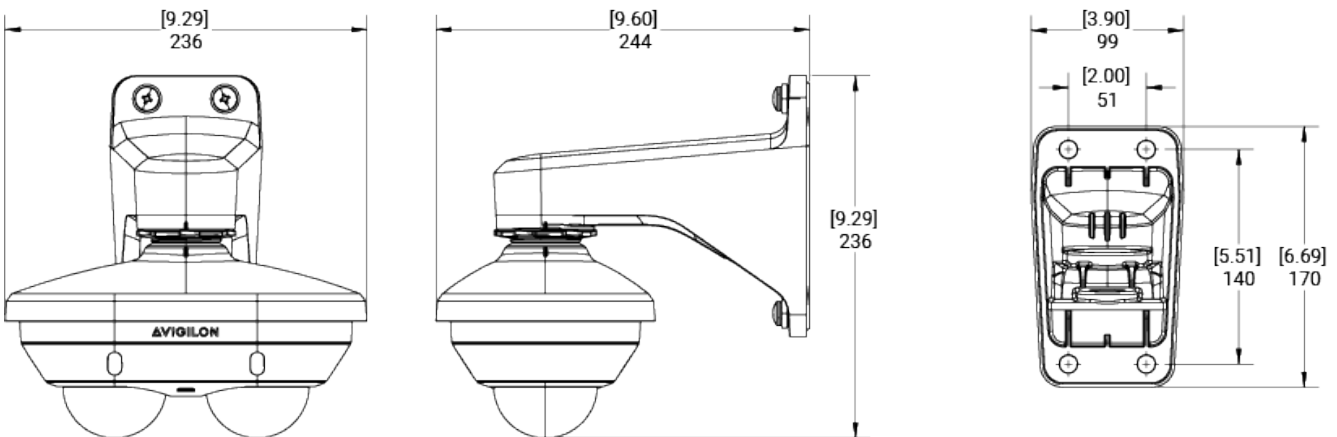

Ordering Information

H6A Dual Head Camera

Models	MP	Lens	Storage
6.0C-H6ADH-DO1-IR-30	2 x 3.0MP	3.24 - 7.33 mm	30 days
6.0C-H6ADH-DO1-IR-60	2 x 3.0MP	3.24 - 7.33 mm	60 days
6.0C-H6ADH-DO1-IR-120	2 x 3.0MP	3.24 - 7.33 mm	120 days
10.0C-H6ADH-DO1-IR-30	2 x 5.0MP	3.24 - 7.33 mm	30 days
10.0C-H6ADH-DO1-IR-60	2 x 5.0MP	3.24 - 7.33 mm	60 days
10.0C-H6ADH-DO1-IR-120	2 x 5.0MP	3.24 - 7.33 mm	120 days
16.0C-H6ADH-DO1-IR-30	2 x 8.0MP	3.24 - 7.33 mm	30 days
16.0C-H6ADH-DO1-IR-60	2 x 8.0MP	3.24 - 7.33 mm	60 days

Camera Accessories

Accessory Part Numbers	
NPTA-1201	Pendant NPT Adapter
WLMT-1021	Pendant wall arm, 1.5" NPT female, 20 cm (7.8") long
JBOX - 1201	Optional junction box mounting adapter
DMSLD-1201	Weathershield for dual head cameras
PLMT-1001	Pole mount adapter
CRNMT-1001	Corner mount adapter



Support

For product support, visit: avigilon.com/support or to contact Sales, email sales@avigilon.com.

To learn more, visit: avigilon.com/h6a-dual-head, or to read the customer documentation, see docs.avigilon.com/bundle/alta-video/page/Products/Cameras.htm.

Jan 2026 | Rev 2



Motorola Solutions, Inc. 500 West Monroe Street, Chicago, IL 60661 U.S.A. motorolasolutions.com

© 2026, Avigilon Corporation. All rights reserved. MOTOROLA, MOTO, MOTOROLA SOLUTIONS and the Stylized M Logo are trademarks or registered trademarks of Motorola Trademark Holdings, LLC and are used under license. All other trademarks are the property of their respective owners.

20260109-en