

DS-1273ZJ-130

Wall Mounting Bracket for Dome Camera

Features:

- Aluminum alloy material with surface spray treatment
- Design with cable entry hole
- Better water proof design
- Convenient installation coordinating with cap

Dimension:

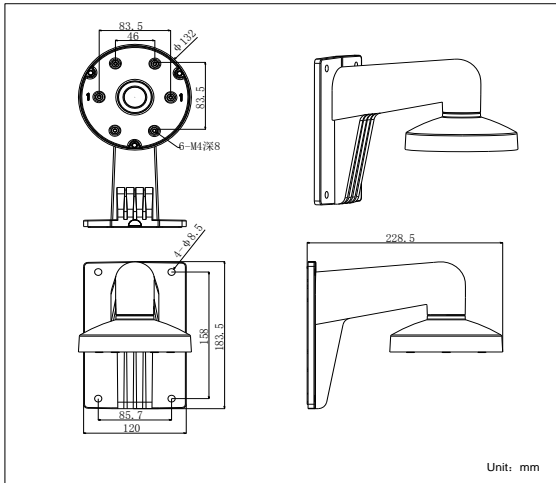

Installation Step:

- ① Choose the appropriate wall to fix the bracket and wire

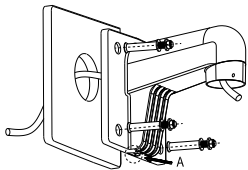

A: Cable entry hole

- ② Fix cap to bracket and complete wiring

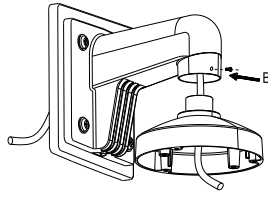

B: Fastening screw

- ③ Screw up and fix the cap

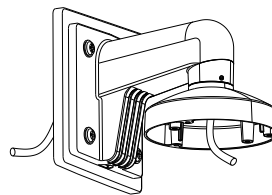

- ④ Take adaptor from the case of dome camera

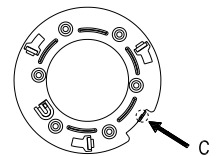

C: Bayonet of adaptor

- ⑤ Check the hole site and fix adaptor to cap

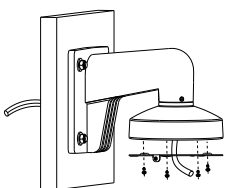

- ⑥ Connect the cable and fix dome camera to cap

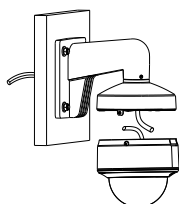

- ⑦ Rotate the dome camera moderately and screw up the fastening screw

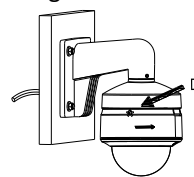

D: Fastening screw on dome

- ⑧ Installation complete

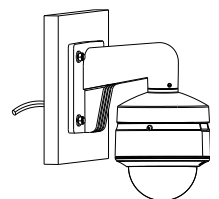

Order Model:

DS-1273ZJ-130

Parameter:

Model	DS-1273ZJ-130
Parameters	Wall Mounting Bracket for Dome Camera
Appearance	Hik White
Range of Application	Suitable for dome camera wall mounting
Material	Aluminum Alloy
Dimension	132×183.5×228.5mm
Weight	690g

Notice:

- The bracket is for dome camera
- Pay attention to the color matching when select bracket
- The bracket should be installed on flat wall
- The wall must be capable of supporting over 3 times as much as the total weight of the camera and the mount.
- The maximum load capacity of the bracket is 4.5KG

Model Suitable:

DS-2CD7X3PF(NF)-E(I)(Z), DS-2CD793PFWD-E(I)(Z)
 DS-2CD793NFWD-E(I)(Z), DS-2CD7X4FWD-E(I)(Z)
 DS-2CD7XXF-E(I)(Z), DS-2CD783F-EP
 DS-2CD4112F-(I), DS-2CD4112FWD-(I)
 DS-2CD4124F-(I), DS-2CD4132FWD-(I)

Note: The actual bracket may vary from the picture above.