



UniFi[®] AC HD

802.11AC Wave 2
Enterprise Wi-Fi Access Point

Model: UAP-AC-HD

QUICK START GUIDE

Introduction

Thank you for purchasing the Ubiquiti Networks® UniFi® 802.11ac Wave 2 Enterprise Wi-Fi Access Point. This Quick Start Guide is designed to guide you through installation and includes warranty terms.

! **Important:** The UAP-AC-HD requires the UniFi Controller v5.3 or newer, available at: downloads.ubnt.com/unifi

Package Contents



UniFi AP AC HD



Mounting Bracket



Ceiling Backing Plate



Flat Head Screws
(Qty. 4)



Keps Nuts
(Qty. 4)



Screws
(Qty. 4)



Screw Anchors
(Qty. 4)



Gigabit PoE* (48V, 0.5A)
with Mount Bracket



Power Cord*



Quick Start
Guide

* Included only in the single-pack of the UAP-AC-HD

TERMS OF USE: Ubiquiti radio devices must be professionally installed. Shielded Ethernet cable and earth grounding must be used as conditions of product warranty. TOUGHcable™ is designed for outdoor installations. It is the customer's responsibility to follow local country regulations, including operation within legal frequency channels, output power, and Dynamic Frequency Selection (DFS) requirements.

Installation Requirements

- Phillips screwdriver
- Drill and drill bit (6 mm for wall-mounting or 3 mm for ceiling-mounting)
- Optional: Drywall or keyhole saw (to cut 18 mm hole for Ethernet cable feed)
- Cat5/6 UTP cable for indoor installations

Outdoor Installation Requirements

 **Important:** The UAP-AC-HD may be installed outdoors under an eave or other protected location. Do not install the UniFi AP in an open environment.

- Mounting location should be at least 60 cm (2 ft) from the edge of the eave or ceiling.
- Cable feed opening must be directed away from the open environment.
- Cable feed must be pointed downwards when wall-mounted.
- Shielded Category 5 (or above) cabling should be used for all outdoor wired Ethernet connections and should be grounded through the AC ground of the PoE.

We recommend that you protect your networks from harmful outdoor environments and destructive ESD events with industrial-grade, shielded Ethernet cable from Ubiquiti Networks. For more details, visit

www.ubnt.com/toughcable

System Requirements

- Linux, Mac OS X, or Microsoft Windows 7/8/10
- Java Runtime Environment 1.6 (1.8 or newer recommended)
- Web Browser: Google Chrome (Other browsers may have limited functionality)
- UniFi Controller software v5.3 or newer (available at: **downloads.ubnt.com/unifi**)

Network Topology Requirements

- A DHCP-enabled network (for the AP to obtain an IP address as well as for the wireless clients after deployment)
- A UniFi Cloud Key or management station running the UniFi Controller v5.3 (or newer) software, located either on-site and connected to the same Layer-2 network, or off-site in the cloud or NOC

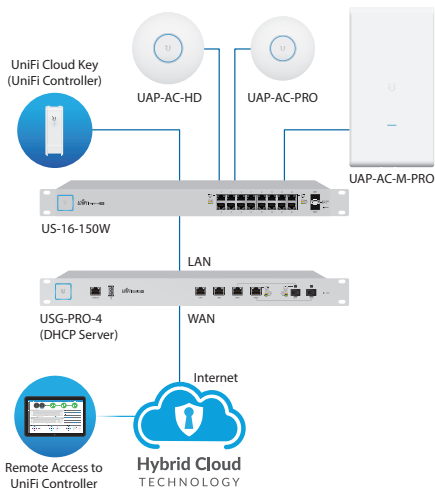

Sample Network Diagram

All UniFi devices support off-site management controllers. For setup details, see the User Guide on the website: documentation.ubnt.com/unifi

Hardware Overview

LED



LED Color	Status
White	Factory default, waiting to be integrated.
Flashing White	Initializing.
Alternating White/Blue	Device is busy; do not touch or unplug it. This usually indicates that a process such as a firmware upgrade is taking place.
Blue	Indicates the device has been successfully integrated into a network and is working properly.
Quickly Flashing Blue	This is used to locate an AP. When you click Locate in the UniFi Controller software, the AP will flash. It will also display the location of the AP on the map.
Steady Blue with occasional flashing	Indicates the device is in an isolated state (all WLANs are brought down until an uplink is found).

Ports

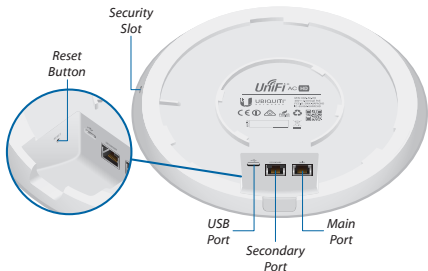

Reset The *Reset* button serves two functions for the UniFi AP:

- **Restart** Press and release the *Reset* button quickly.
- **Restore to Factory Default Settings** Press and hold the *Reset* button for more than five seconds.

USB The *USB* Type-C port is reserved for future use.

Secondary The *Secondary* port is a Gigabit Ethernet port used for bridging.

Main The *Main* port is a Gigabit Ethernet port used to connect the power and should be connected to the LAN and DHCP server.

 **Note:** If you need to remove the UniFi AP from the *Mounting Bracket*, insert a straightened paper clip in the *Security Slot* to release the *Lock Tab* and turn the UniFi AP counterclockwise.

Upgrade from UAP-AC-PRO

The UAP-AC-HD uses the same mounting hardware as the UAP-AC-PRO, so you only need to remove the UAP-AC-PRO and replace it with the UAP-AC-HD.

To begin the upgrade, perform the following steps:

1. Insert a straightened paper clip into the UAP-AC-PRO *Locking Notch* to disengage the lock. Then turn the UAP-AC-PRO counterclockwise and lift it off of the mounting bracket.

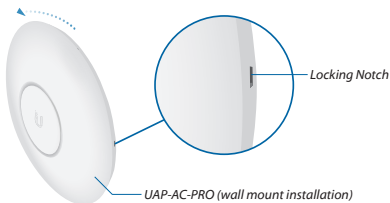

2. Unplug the Ethernet cable from the *Main* port.
3. Go to step 4 of the *Wall Mount* section or step 5 of the *Ceiling Mount* section.

Hardware Installation

The UniFi AP can be mounted on the wall or ceiling. Perform the steps for the appropriate installation:

Wall Mount

1. Position the *Mounting Bracket* at the desired location on the wall with the *Arrow* pointing up.
2. Mark the four mounting holes, and use a 6 mm drill bit to drill the holes. If your Ethernet cable feeds through the wall, cut or drill a circle approximately 18 mm in diameter. Then feed the CAT5/6 cable through the hole.

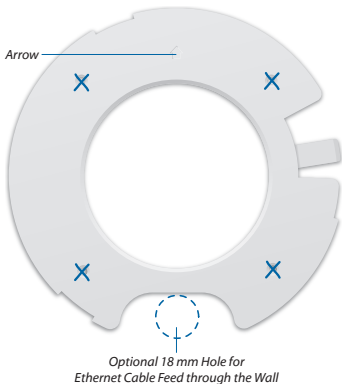

3. Insert the *Screw Anchors* into the holes. Secure the *Mounting Bracket* to the wall by inserting the *Screws* into the anchors.

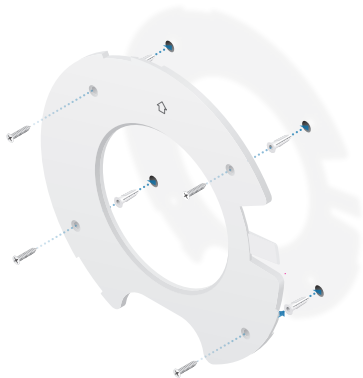

4. Remove the rubber port cover from the UniFi AP.



5. If the Ethernet cable is fed through the wall, skip to step 6. If the Ethernet cable runs along the mounting surface, remove the cable feed plug.



6. Feed the Ethernet cable through the port cover.



Note: The feed hole will stretch to accommodate the RJ45 connector, and then seal around the cable.

7. Connect the Ethernet cable to the *Main* port and replace the port cover.



8. Align the *Notch* on the top edge of the UniFi AP with the *Arrow* on the *Mounting Bracket*.

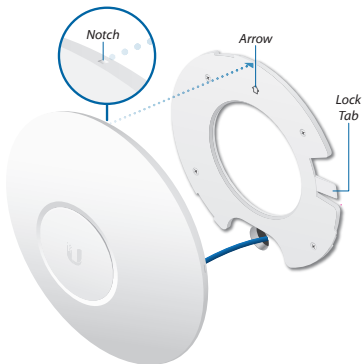

9. Rotate the UniFi AP clockwise until the tabs lock into place and the *Lock Tab* engages.



Ceiling Mount

1. Remove the ceiling tile.
2. Place the *Ceiling Backing Plate* in the center of the ceiling tile. Mark the four mounting screw holes and a 18 mm hole for the Ethernet cable feed.

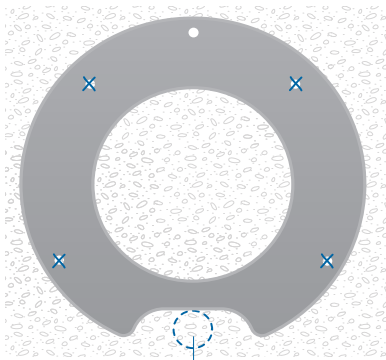

*Optional 18 mm Hole for
Ethernet Cable Feed through the Wall*

3. Use a 3 mm drill bit to drill the screw holes, and cut or drill the hole for the Ethernet cable feed.

4. Insert the *Flat Head Screws* through the *Mounting Bracket*, ceiling tile, and *Ceiling Backing Plate*. Fasten the screws using the *Keps Nuts*. Then feed the Ethernet cable through the tile and bracket.

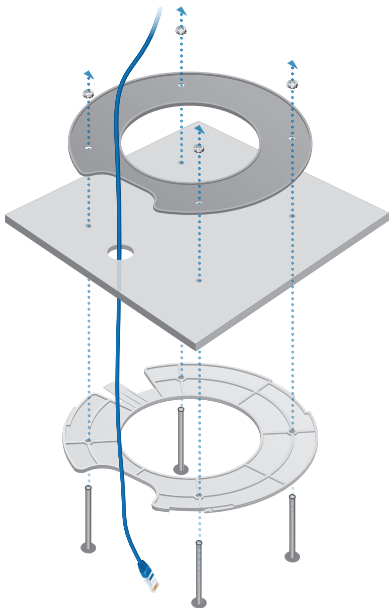

5. Remove the port cover from the UniFi AP, and then feed the Ethernet cable through the port cover.



Note: The feed hole will stretch to accommodate the RJ45 connector, and then seal around the cable.

6. Connect the Ethernet cable to the *Main* port and replace the port cover.

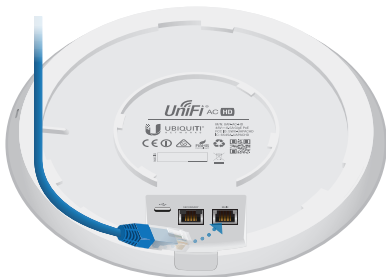

640-00250-01

7. Align the *Notch* on the top edge of the UniFi AP with the *Arrow* on the *Mounting Bracket*.

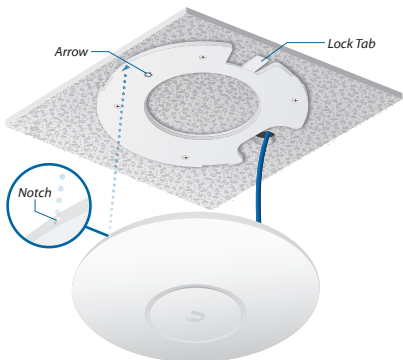

8. Rotate the UniFi AP clockwise until the tabs lock into place and the *Lock Tab* engages.



9. Set the ceiling tile back into place.

Powering the UniFi AP

The UAP-AC-HD features auto-sensing 802.3at PoE+ support and can be powered by any of the following:

- Ubiquiti Networks UniFi Switch with PoE
- 802.3at PoE+ compliant switch
- Ubiquiti Networks Gigabit PoE Adapter (48V, 0.5A)

The single-pack of the UAP-AC-HD includes one *Gigabit PoE* adapter. For multi-pack units, PoE adapters or a UniFi Switch with PoE may be purchased separately.

Connecting to a PoE+ Switch

Connect the Ethernet cable from the UniFi AP directly to a PoE+ port on the switch.



Connecting to a PoE Adapter

1. Connect the Ethernet cable from the UniFi AP to the **POE** port of the *Gigabit PoE* adapter.
2. Connect an Ethernet cable from your LAN to the **LAN** port of the *Gigabit PoE* adapter.
3. Connect the *Power Cord* to the adapter, and then plug the *Power Cord* into a power outlet.



Mounting the PoE Adapter (Optional)

1. Remove the *PoE Mounting Bracket* from the adapter, place the bracket at the desired location, and mark the two holes.
2. Pre-drill the holes if necessary, and secure the bracket using two fasteners (not included).
3. Align the adapter's slots with the tabs of the *PoE Mounting Bracket*, and then slide the adapter down.



Software Installation

Download and install the latest version of the UniFi Controller software at: downloads.ubnt.com/unifi

Launch the software and follow the on-screen instructions. Step-by-step instructions are available in the User Guide located on our website: documentation.ubnt.com/unifi

After you have installed the software and run the UniFi Installation Wizard, a login screen will appear for the UniFi Controller management interface. Enter the Admin Name and Password that you created and click **Log In**.



You can manage your wireless network and view network statistics using the UniFi Controller management interface. For information on configuring and using the UniFi Controller software, refer to the User Guide.

Mobile App Installation

Ubiquiti Networks also offers the UniFi mobile app, which is available from the App Store (iOS) or Google Play™ Store (Android). You can use it to provision a UniFi AP for basic functionality without configuring a UniFi Controller. It also allows seamless provisioning of APs for remote controllers (controllers not on the same layer-2 network) and easy access to both local controllers and those monitored on unifi.ubnt.com.

Specifications

UAP-AC-HD	
Dimensions	220 x220 x 48.1 mm (8.66 x 8.66 x 1.89")
Weight with Mounting Kit	530 g (1.17 lb) 660 g (1.46 lb)
Networking Interface	(2) 10/100/1000 Ethernet Ports
Buttons	Reset
Power Method	PoE+ 802.3at
Power Supply	48V, 0.5A Gigabit PoE Adapter*
Max. Power Consumption	12W
Max. TX Power 2.4 GHz 5 GHz	25 dBm 25 dBm
Antennas 2.4 GHz 5 GHz	(2) Antennas, 3 dBi each (2) Antennas, 4 dBi each
Wi-Fi Standards	802.11 a/b/g/n/ac/ac-wave2
Wireless Security	WEP, WPA-PSK, WPA-Enterprise (WPA/WPA2, TKIP/AES)
Mounting	Wall/Ceiling (Kits Included)
Operating Temperature	-10 to 70° C (14 to 158° F)
Operating Humidity	5 to 95% Noncondensing
Certifications	CE, FCC, IC

* Included with the single-pack of the UAP-AC-HD

Safety Notices

1. Read, follow, and keep these instructions.
2. Heed all warnings.
3. Only use attachments/accessories specified by the manufacturer.



WARNING: Do not use this product in location that can be submerged by water.



WARNING: Avoid using this product during an electrical storm. There may be a remote risk of electric shock from lightning.

Electrical Safety Information

1. Compliance is required with respect to voltage, frequency, and current requirements indicated on the manufacturer's label. Connection to a different power source than those specified may result in improper operation, damage to the equipment or pose a fire hazard if the limitations are not followed.
2. There are no operator serviceable parts inside this equipment. Service should be provided only by a qualified service technician.
3. This equipment is provided with a detachable power cord which has an integral safety ground wire intended for connection to a grounded safety outlet.
 - a. Do not substitute the power cord with one that is not the provided approved type. Never use an adapter plug to connect to a 2-wire outlet as this will defeat the continuity of the grounding wire.
 - b. The equipment requires the use of the ground wire as a part of the safety certification, modification or misuse can provide a shock hazard that can result in serious injury or death.
 - c. Contact a qualified electrician or the manufacturer if there are questions about the installation prior to connecting the equipment.
 - d. Protective earthing is provided by Listed AC adapter. Building installation shall provide appropriate short-circuit backup protection.
 - e. Protective bonding must be installed in accordance with local national wiring rules and regulations.

Limited Warranty

UBIQUITI NETWORKS, Inc (“UBIQUITI NETWORKS”) warrants that the product(s) furnished hereunder (the “Product(s)”) shall be free from defects in material and workmanship for a period of one (1) year from the date of shipment by UBIQUITI NETWORKS under normal use and operation. UBIQUITI NETWORKS’ sole and exclusive obligation and liability under the foregoing warranty shall be for UBIQUITI NETWORKS, at its discretion, to repair or replace any Product that fails to conform to the above warranty during the above warranty period. The expense of removal and reinstallation of any Product is not included in this warranty. The warranty period of any repaired or replaced Product shall not extend beyond its original term.

Warranty Conditions

The above warranty does not apply if the Product:

- (I) has been modified and/or altered, or an addition made thereto, except by Ubiquiti Networks, or Ubiquiti Networks’ authorized representatives, or as approved by Ubiquiti Networks in writing;
- (II) has been painted, rebranded or physically modified in any way;
- (III) has been damaged due to errors or defects in cabling;
- (IV) has been subjected to misuse, abuse, negligence, abnormal physical, electromagnetic or electrical stress, including lightning strikes, or accident;
- (V) has been damaged or impaired as a result of using third party firmware;
- (VI) has no original Ubiquiti MAC label, or is missing any other original Ubiquiti label(s); or
- (VII) has not been received by Ubiquiti within 30 days of issuance of the RMA.

In addition, the above warranty shall apply only if: the product has been properly installed and used at all times in accordance, and in all material respects, with the applicable Product documentation; all Ethernet cabling runs use CAT5 (or above), and for outdoor installations, shielded Ethernet cabling is used, and for indoor installations, indoor cabling requirements are followed.

Returns

No Products will be accepted for replacement or repair without obtaining a Return Materials Authorization (RMA) number from UBIQUITI NETWORKS during the warranty period, and the Products being received at UBIQUITI NETWORKS’ facility freight prepaid in accordance with the RMA process of UBIQUITI NETWORKS. Products returned without an RMA number will not be processed and will be returned freight collect or subject to disposal. Information on the RMA process and obtaining an RMA number can be found at: www.ubnt.com/support/warranty.

Disclaimer

EXCEPT FOR ANY EXPRESS WARRANTIES PROVIDED HEREIN, UBIQUITI NETWORKS, ITS AFFILIATES, AND ITS AND THEIR THIRD PARTY DATA, SERVICE, SOFTWARE AND HARDWARE PROVIDERS HEREBY DISCLAIM AND MAKE NO OTHER REPRESENTATION OR WARRANTY OF ANY KIND, EXPRESS, IMPLIED OR STATUTORY, INCLUDING, BUT NOT LIMITED TO, REPRESENTATIONS, GUARANTEES, OR WARRANTIES OF MERCHANTABILITY, ACCURACY, QUALITY OF SERVICE OR RESULTS, AVAILABILITY, SATISFACTORY QUALITY, LACK OF VIRUSES, QUIET ENJOYMENT, FITNESS FOR A PARTICULAR PURPOSE AND NON-INFRINGEMENT AND ANY WARRANTIES ARISING FROM ANY COURSE OF DEALING, USAGE OR TRADE PRACTICE IN CONNECTION WITH SUCH PRODUCTS AND SERVICES. BUYER ACKNOWLEDGES THAT NEITHER UBIQUITI NETWORKS NOR ITS THIRD PARTY PROVIDERS CONTROL BUYER'S EQUIPMENT OR THE TRANSFER OF DATA OVER COMMUNICATIONS FACILITIES, INCLUDING THE INTERNET, AND THAT THE PRODUCTS AND SERVICES MAY BE SUBJECT TO LIMITATIONS, INTERRUPTIONS, DELAYS, CANCELLATIONS AND OTHER PROBLEMS INHERENT IN THE USE OF COMMUNICATIONS FACILITIES. UBIQUITI NETWORKS, ITS AFFILIATES AND ITS AND THEIR THIRD PARTY PROVIDERS ARE NOT RESPONSIBLE FOR ANY INTERRUPTIONS, DELAYS, CANCELLATIONS, DELIVERY FAILURES, DATA LOSS, CONTENT CORRUPTION, PACKET LOSS, OR OTHER DAMAGE RESULTING FROM ANY OF THE FOREGOING. In addition, UBIQUITI NETWORKS does not warrant that the operation of the Products will be error-free or that operation will be uninterrupted. In no event shall UBIQUITI NETWORKS be responsible for damages or claims of any nature or description relating to system performance, including coverage, buyer's selection of products (including the Products) for buyer's application and/or failure of products (including the Products) to meet government or regulatory requirements.

Limitation of Liability

EXCEPT TO THE EXTENT PROHIBITED BY LOCAL LAW, IN NO EVENT WILL UBIQUITI OR ITS SUBSIDIARIES, AFFILIATES OR SUPPLIERS BE LIABLE FOR DIRECT, SPECIAL, INCIDENTAL, CONSEQUENTIAL OR OTHER DAMAGES (INCLUDING LOST PROFIT, LOST DATA, OR DOWNTIME COSTS), ARISING OUT OF THE USE, INABILITY TO USE, OR THE RESULTS OF USE OF THE PRODUCT, WHETHER BASED IN WARRANTY, CONTRACT, TORT OR OTHER LEGAL THEORY, AND WHETHER OR NOT ADVISED OF THE POSSIBILITY OF SUCH DAMAGES.

Note

Some countries, states and provinces do not allow exclusions of implied warranties or conditions, so the above exclusion may not apply to you. You may have other rights that vary from country to country, state to state, or province to province. Some countries, states and provinces do not allow the exclusion or limitation of liability for incidental or consequential

damages, so the above limitation may not apply to you. EXCEPT TO THE EXTENT ALLOWED BY LOCAL LAW, THESE WARRANTY TERMS DO NOT EXCLUDE, RESTRICT OR MODIFY, AND ARE IN ADDITION TO, THE MANDATORY STATUTORY RIGHTS APPLICABLE TO THE LICENSE OF ANY SOFTWARE (EMBEDDED IN THE PRODUCT) TO YOU. The United Nations Convention on Contracts for the International Sale of Goods shall not apply to any transactions regarding the sale of the Products.

Compliance

FCC

Changes or modifications not expressly approved by the party responsible for compliance could void the user's authority to operate the equipment.

This device complies with Part 15 of the FCC Rules. Operation is subject to the following two conditions.

1. This device may not cause harmful interference, and
2. This device must accept any interference received, including interference that may cause undesired operation.

This equipment has been tested and found to comply with the limits for a Class A digital device, pursuant to part 15 of the FCC Rules. These limits are designed to provide reasonable protection against harmful interference when the equipment is operated in a commercial environment. This equipment generates, uses, and can radiate radio frequency energy and, if not installed and used in accordance with the instruction manual, may cause harmful interference to radio communications. Operations of this equipment in a residential area is likely to cause harmful interference in which case the user will be required to correct the interference at his own expense.

This radio transmitter (FCC: SWX-UAPACHD) has been approved by FCC to operate with the antenna types listed below with the maximum permissible gain and required antenna impedance for each antenna type indicated. Antenna types not included in this list, having a gain greater than the maximum gain indicated for that type, are strictly prohibited for use with this device.

Antenna Information: 2.4 GHz, dual-polarity antenna, Gain: 3 dBi; 5 GHz, dual-polarity antenna, Gain: 4 dBi

Industry Canada

CAN ICES-3(A)/NMB-3(A)

This Class A digital apparatus complies with Canadian ICES-003.

To reduce potential radio interference to other users, the antenna type and its gain should be so chosen that the equivalent isotropically radiated power (e.i.r.p.) is not more than that permitted for successful communication.

This device complies with Industry Canada licence-exempt RSS standard(s). Operation is subject to the following two conditions:

1. This device may not cause interference, and
2. This device must accept any interference, including interference that may cause undesired operation of the device.

This radio transmitter (IC: 6545A-UAPACHD) has been approved by Industry Canada to operate with the antenna types listed below with the maximum permissible gain and required antenna impedance for each antenna type indicated. Antenna types not included in this list, having a gain greater than the maximum gain indicated for that type, are strictly prohibited for use with this device.

Antenna Information: 2.4 GHz, dual-polarity antenna, Gain: 3 dBi; 5 GHz, dual-polarity antenna, Gain: 4 dBi

The device for operation in the band 5150– 5250 MHz is only for indoor use to reduce the potential for harmful interference to co-channel mobile satellite systems. Users should also be advised that high-power radars are allocated as primary users (i.e. priority users) of the bands 5250-5350 MHz and 5650-5850 MHz and that these radars could cause interference and/or damage to LE-LAN devices.

CAN ICES-3(A)/NMB-3(A)

Cet appareil numérique de la classe A est conforme à la norme NMB-003 du Canada.

Pour réduire le risque d'interférence aux autres utilisateurs, le type d'antenne et son gain doivent être choisis de façon que la puissance isotrope rayonnée équivalente (PIRE) ne dépasse pas ce qui est nécessaire pour une communication réussie.

Cet appareil est conforme à la norme RSS Industrie Canada exempts de licence norme(s). Son fonctionnement est soumis aux deux conditions suivantes:

1. Cet appareil ne peut pas provoquer d'interférences et
2. Cet appareil doit accepter toute interférence, y compris les interférences qui peuvent causer un mauvais fonctionnement du dispositif.

Cet émetteur radio (IC: 6545A-UAPACHD) a été approuvée par Industrie Canada pour l'exploitation avec l'antenne types énumérés ci-dessous avec le gain maximal admissible et requis l'impédance de l'antenne pour chaque type d'antenne indiqué. Types d'antenne non inclus dans cette liste, ayant un gain supérieur au gain maximal indiqué pour ce type, sont strictement interdits pour une utilisation avec cet appareil.

Informations d'antenne: Antenne 2,4 GHz, double-polarité, Gain: 3 dBi; Antenne 5 GHz, double-polarité, Gain: 4 dBi

Les dispositifs fonctionnant dans la bande de 5 150 à 5 250 MHz sont réservés uniquement pour une utilisation à l'intérieur afin de réduire les risques de brouillage préjudiciable aux systèmes de satellites mobiles utilisant les mêmes canaux.

Les utilisateurs devraient aussi être avisés, d'une part, que les utilisateurs de radars de haute puissance sont désignés utilisateurs principaux (c.-à-d., qu'ils ont la priorité) des bandes de 5 250 à 5 350 MHz et de 5 650 à 5 850 MHz et, d'autre part, que ces radars pourraient causer du brouillage et/ou des dommages aux dispositifs de RL-EL.

RF Exposure Warning

The antennas used for this transmitter must be installed to provide a separation distance of at least 21 cm from all persons and must not be located or operating in conjunction with any other antenna or transmitter, except as listed for this product's certification.

Les antennes utilisées pour cet émetteur doit être installé pour fournir une distance de séparation d'au moins 21 cm de toutes les personnes et ne doit pas être situé ou opérant en conjonction avec une autre antenne ou un autre émetteur, sauf dans les cas énumérés à la certification de ce produit.

CE Marking

CE marking on this product represents the product is in compliance with all directives that are applicable to it.

Alert Sign (!) Follows CE Marking

Alert sign must be indicated if a restriction on use applied to the product and it must follow the CE marking.

RoHS/WEEE Compliance Statement



English

European Directive 2012/19/EU requires that the equipment bearing this symbol on the product and/or its packaging must not be disposed of with unsorted municipal waste. The symbol indicates that this product should be disposed of separately from regular household waste streams. It is your responsibility to dispose of this and other electric and electronic equipment via designated collection facilities appointed by the government or local authorities. Correct disposal and recycling will help prevent potential negative consequences to the environment and human health. For more detailed information about the disposal of your old equipment, please contact your local authorities, waste disposal service, or the shop where you purchased the product.

Deutsch

Die Europäische Richtlinie 2012/19/EU verlangt, dass technische Ausrüstung, die direkt am Gerät und/oder an der Verpackung mit diesem Symbol versehen ist, nicht zusammen mit unsortiertem Gemeindeabfall entsorgt werden darf. Das Symbol weist darauf hin, dass das Produkt von regulärem Haushaltsmüll getrennt entsorgt werden sollte. Es liegt in Ihrer Verantwortung, dieses Gerät und andere elektrische und elektronische Geräte über die dafür zuständigen und von der Regierung oder örtlichen Behörden dazu bestimmten Sammelstellen zu entsorgen. Ordnungsgemäßes Entsorgen und Recyceln trägt dazu bei, potentielle negative Folgen für Umwelt und die menschliche Gesundheit zu vermeiden. Wenn Sie weitere Informationen zur Entsorgung Ihrer Altgeräte benötigen, wenden Sie sich bitte an die örtlichen Behörden oder städtischen Entsorgungsdienste oder an den Händler, bei dem Sie das Produkt erworben haben.

Español

La Directiva 2012/19/UE exige que los equipos que lleven este símbolo en el propio aparato y/o en su embalaje no deben eliminarse junto con otros residuos urbanos no seleccionados. El símbolo indica que el producto en cuestión debe separarse de los residuos domésticos convencionales con vistas a su eliminación. Es responsabilidad suya desechar este y cualesquiera otros aparatos eléctricos y electrónicos a través de los puntos de recogida que ponen a su disposición el gobierno y las autoridades locales. Al desechar y reciclar correctamente estos aparatos estará contribuyendo a evitar posibles consecuencias negativas para el medio ambiente y la salud de las personas. Si desea obtener información más detallada sobre la eliminación segura de su aparato usado, consulte a las autoridades locales, al servicio de recogida y eliminación de residuos de su zona o pregunte en la tienda donde adquirió el producto.

Français

La directive européenne 2012/19/UE exige que l'équipement sur lequel est apposé ce symbole sur le produit et/ou son emballage ne soit pas jeté avec les autres ordures ménagères. Ce symbole indique que le produit doit être éliminé dans un circuit distinct de celui pour les déchets des ménages. Il est de votre responsabilité de jeter ce matériel ainsi que tout autre matériel électrique ou électronique par les moyens de collecte indiqués par le gouvernement et les pouvoirs publics des collectivités territoriales. L'élimination et le recyclage en bonne et due forme ont pour but de lutter contre l'impact néfaste potentiel de ce type de produits sur l'environnement et la santé publique. Pour plus d'informations sur le mode d'élimination de votre ancien équipement, veuillez prendre contact avec les pouvoirs publics locaux, le service de traitement des déchets, ou l'endroit où vous avez acheté le produit.

Italiano

La direttiva europea 2012/19/UE richiede che le apparecchiature contrassegnate con questo simbolo sul prodotto e/o sull'imballaggio non siano smaltite insieme ai rifiuti urbani non differenziati. Il simbolo indica che questo prodotto non deve essere smaltito insieme ai normali rifiuti domestici. È responsabilità del proprietario smaltire sia questi prodotti sia le altre apparecchiature elettriche ed elettroniche mediante le specifiche strutture di raccolta indicate dal governo o dagli enti pubblici locali. Il corretto smaltimento ed il riciclaggio aiuteranno a prevenire conseguenze potenzialmente negative per l'ambiente e per la salute dell'essere umano. Per ricevere informazioni più dettagliate circa lo smaltimento delle vecchie apparecchiature in Vostro possesso, Vi invitiamo a contattare gli enti pubblici di competenza, il servizio di smaltimento rifiuti o il negozio nel quale avete acquistato il prodotto.

Declaration of Conformity

Česky [Czech]	UBIQUITI NETWORKS tímto prohlašuje, že toto UBIQUITI NETWORKS zařízení, je ve shod se základními požadavky a dalšími příslušnými ustanoveními směrnice 1999/5/ES.
Dansk [Danish]	Hermed, UBIQUITI NETWORKS, erklærer at denne UBIQUITI NETWORKS enhed, er i overensstemmelse med de væsentlige krav og øvrige relevante krav i direktiv 1999/5/EF.
Nederlands [Dutch]	Hierbij verklaart UBIQUITI NETWORKS, dat deze UBIQUITI NETWORKS apparaat, in overeenstemming is met de essentiële eisen en de andere relevante bepalingen van richtlijn 1999/5/EG.
English	Hereby, UBIQUITI NETWORKS, declares that this UBIQUITI NETWORKS device, is in compliance with the essential requirements and other relevant provisions of Directive 1999/5/EC.
Eesti [Estonian]	Käesolevaga UBIQUITI NETWORKS kinnitab, et antud UBIQUITI NETWORKS seade, on vastavus olulistele nõuetele ja teistele asjakohastele sätetele direktiivi 1999/5/EÜ.
Suomi [Finnish]	Täten UBIQUITI NETWORKS vakuuttaa, että tämä UBIQUITI NETWORKS laite, on yhdenmukainen olennaisten vaatimusten ja muiden sitä koskevien direktiivin 1999/5/EY.
Français [French]	Par la présente UBIQUITI NETWORKS déclare que l'appareil UBIQUITI NETWORKS, est conforme aux exigences essentielles et aux autres dispositions pertinentes de la directive 1999/5/CE.
Deutsch [German]	Hiermit erklärt UBIQUITI NETWORKS, dass sich dieses UBIQUITI NETWORKS Gerät, in Übereinstimmung mit den grundlegenden Anforderungen und den anderen relevanten Vorschriften der Richtlinie 1999/5/EG befindet.
Ελληνική [Greek]	Δια του παρόντος, UBIQUITI NETWORKS, δηλώνει ότι αυτή η συσκευή UBIQUITI NETWORKS, είναι σε συμμόρφωση με τις βασικές απαιτήσεις και τις λοιπές σχετικές διατάξεις της οδηγίας 1995/5/EK.
Magyar [Hungarian]	Ezennel UBIQUITI NETWORKS kijelenti, hogy ez a UBIQUITI NETWORKS készülék megfelel az alapvető követelményeknek és más vonatkozó 1999/5/EK irányelv rendelkezéseit.
Íslenska [Icelandic]	Hér, UBIQUITI NETWORKS, því yfir að þetta UBIQUITI NETWORKS tæki er í samræmi við grunnkröfur og önnur viðeigandi ákvæði tilskipun 1999/5/EB.
Italiano [Italian]	Con la presente, UBIQUITI NETWORKS, dichiara che questo dispositivo UBIQUITI NETWORKS, è conforme ai requisiti essenziali ed alle altre disposizioni pertinenti della direttiva 1999/5/CE.
Latviski [Latvian]	Ar šo, UBIQUITI NETWORKS, deklarē, ka UBIQUITI NETWORKS ierīce, ir saskaņā ar būtiskajām prasībām un citiem attiecīgiem noteikumiem Direktīvā 1999/5/EK.

Lietuviškai [Lithuanian]	UBIQUITI NETWORKS deklaruoja, kad šis UBIQUITI NETWORKS įrenginys atitinka esminius reikalavimus ir kitas 1999/5/EB Direktyvos nuostatas.
Malti [Maltese]	Hawnhekk, UBIQUITI NETWORKS, tiddikjara li dan il-mezz UBIQUITI NETWORKS huwa konformi mar-rekwiżiti essenzjali u dispozizzjonijiet rilevanti oħrajn ta 'Direttiva 1999/5/KE.
Norsk [Norwegian]	Herved UBIQUITI NETWORKS, erklærer at denne UBIQUITI NETWORKS enheten, er i samsvar med de grunnleggende kravene og andre relevante bestemmelser i direktiv 1999/5/EF.
Polski [Polish]	Niniejszym, Ubiquiti Networks, oświadcza, że urządzenie UBIQUITI NETWORKS, jest zgodny z zasadniczymi wymaganiami oraz pozostałymi stosownymi postanowieniami Dyrektywy 1999/5/WE.
Português [Portuguese]	UBIQUITI NETWORKS declara que este dispositivo UBIQUITI NETWORKS, está conforme com os requisitos essenciais e outras disposições da Directiva 1999/5/CE.
Română [Romanian]	Prin prezenta, UBIQUITI NETWORKS declară că acest dispozitiv UBIQUITI NETWORKS este în conformitate cu cerințele esențiale și alte prevederi relevante ale Directivei 1999/5/CE.
Slovensky [Slovak]	Týmto UBIQUITI NETWORKS, prehlasuje, že toto UBIQUITI NETWORKS zariadenie, je v súlade so základnými požiadavkami a ďalšími relevantnými ustanoveniami smernice 1999/5/ES.
Español [Spanish]	Por medio de la presente UBIQUITI NETWORKS declara que este dispositivo UBIQUITI NETWORKS, cumple con los requisitos esenciales y cualesquiera otras disposiciones aplicables o exigibles de la Directiva 1999/5/CE.
Svenska [Swedish]	Härmed UBIQUITI NETWORKS, intygar att denna UBIQUITI NETWORKS enhet är i överensstämmelse med de väsentliga egenskapskrav och övriga relevanta bestämmelser som framgår av direktiv 1999/5/EG.

Online Resources

Support help.ubnt.com

Community community.ubnt.com

Downloads downloads.ubnt.com



©2016 Ubiquiti Networks, Inc. All rights reserved. Ubiquiti, Ubiquiti Networks, the Ubiquiti U logo, the Ubiquiti beam logo, TOUGHCable, and UniFi are trademarks or registered trademarks of Ubiquiti Networks, Inc. in the United States and in other countries. App Store is a service mark of Apple, Inc. Google, Android, and Google Play are trademarks of Google Inc. All other trademarks are the property of their respective owners.

JL072216