

QuSpot for Teltonika RUTX50

INTEGRATED MULTI-BAND LTE & 5G OMNI ANTENNA + WI-FI OMNI ANTENNA + GPS PLACE TO INSTALL TELTONIKA RUTX50 (ALL-IN-ONE)

QuSpot for RUTX50 is an outdoor antenna designed to provide reliable wireless connectivity in a variety of environments. This product is an all in one solution that integrates a high gain omnidirectional 5G and Wi Fi antennas with RUTX50 into a single IP67 enclosure. Such integration allows implementation of new outdoor RUTX50 solutions.

QuSpot for RUTX50 is an ideal solution for outdoor wireless connectivity in moving applications such as transportation, yachting, boats and camping but also city centres with high signal density.

5G**Wi Fi**
DUALBAND
2.4GHz
5GHz**GPS**
617-4200MHz
7 dBi
OMNI
DIRECTIONAL
IP 67**B
A
N
D**
71

OUTDOOR ANTENNA WORKS IN **ANY**
WEATHER CONDITIONS, IP67



ANTENNA **PERFECTLY MATCHED** WITH
THE ROUTER



PASSIVE **POE SUPPORT**



MADE IN **EUROPE**

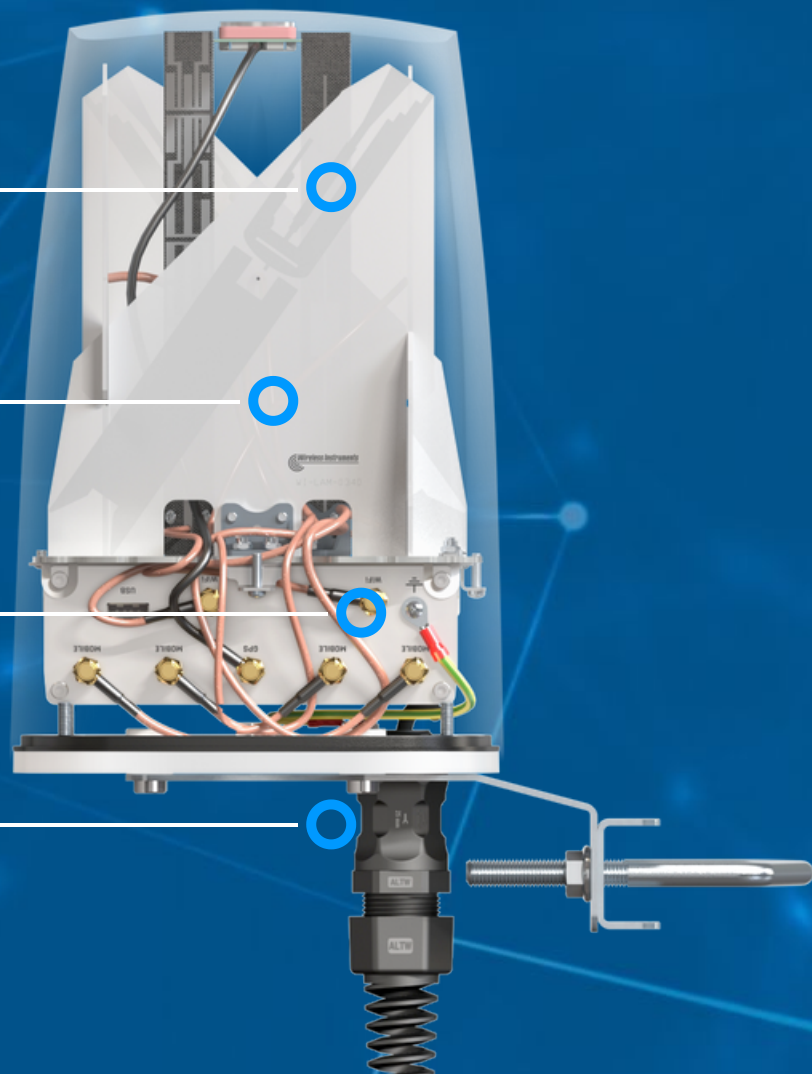

5G ANTENNA SPECIFICATION

FREQUENCY	617 - 960 MHz 1.7 - 2.7 GHz 3.3 - 4.3 GHz
SUPPORTED LTE BANDS	1, 2, 3, 4, 5, 7, 8, 9, 10, 12, 13, 14, 1, 2, 3, 4, 5, 7, 8, 9, 10, 12, 13, 14, 17, 18, 19, 20, 22, 25, 26, 27, 28, 29, 30, 33, 34, 35, 36, 37, 38, 39, 40, 41, 42, 43, 44, 48, 49, 52, 53, 65, 66, 67, 68, 69, 71, 85, 103, 1067, 18, 19, 20, 22, 25, 26, 27, 28, 29, 30, 33, 34, 35, 36, 37, 38, 39, 40, 41, 42, 43, 44, 48, 49, 52, 53, 65, 66, 67, 68, 69, 71, 85, 103, n77, n78, n80, n81, n82, n83, n84, n86, n89, n90, n95, n97, n98, n100, n101
SUPPORTED 5G BANDS	n1, n2, n3, n5, n7, n8, n12, n13, n14, n18, n20, n25, n26, n28, n29, n30, n34, n38, n39, n40, n41, n48, n53, n65, n66, n67, n71, n77, n78, n80, n81, n82, n83, n84, n85, n86, n89, n90, n95, n97, n98, n100, n101, n256
GAIN	617 - 960 MHz : 2 dBi 1.7 - 2.7 GHz : 4 dBi 3.3 - 4.3 GHz : 4.5 dBi
VSWR	<2.00, max <2.50
BEAMWIDTH	360°/25° ±5°
POLARIZATION	Vertical
IMPEDANCE	50 Ω

WI-FI ANTENNA SPECIFICATION

FREQUENCY	2.4 - 2.5 GHz 4.7 - 6 GHz
GAIN	2.4 - 2.5 GHz : 6 dBi 4.7 - 6 GHz : 7.5 dBi
VSWR	<1.70, max <2.00
BEAMWIDTH	360°/25° ±5°
POLARIZATION	Vertical
IMPEDANCE	50 Ω

MECHANICAL SPECIFICATION

MATERIALS	ABS, aluminum, PTFE
CONNECTOR TYPE	RJ45
INGRESS PROTECTION	IP67
DIMENSIONS	160 x 160 x 240 mm 6.3 x 6.3 x 9.45 inch
WEIGHT	1.5 kg 3.31 lbs
OPERATING TEMPERATURE	From -40°C to 75°C From -40°F to 167°F

FREQUENCY BANDS

LTE / 4G

	1	2	3	4	5	7	8	
	9	10	12	13	14	17	18	
	19	20	22	25	26	27	28	
617 MHz	29	30	33	34	35	36	37	4300 MHz
	38	39	40	41	42	43	44	
	48	49	52	53	65	66	67	
	68	69	71	85	103	106		

5G

	n1	n2	n3	n5	n7	n8	n12	
	n13	n14	n18	n20	n25	n26	n28	
	n29	n30	n34	n38	n39	n40	n41	
617 MHz	n48	n53	n65	n66	n67	n71	n77	4300 MHz
	n78	n80	n81	n82	n83	n84	n85	
	n86	n89	n90	n95	n97	n98	n100	
	n101	n256						

PLOTS

VSWR for 5G/LTE antenna

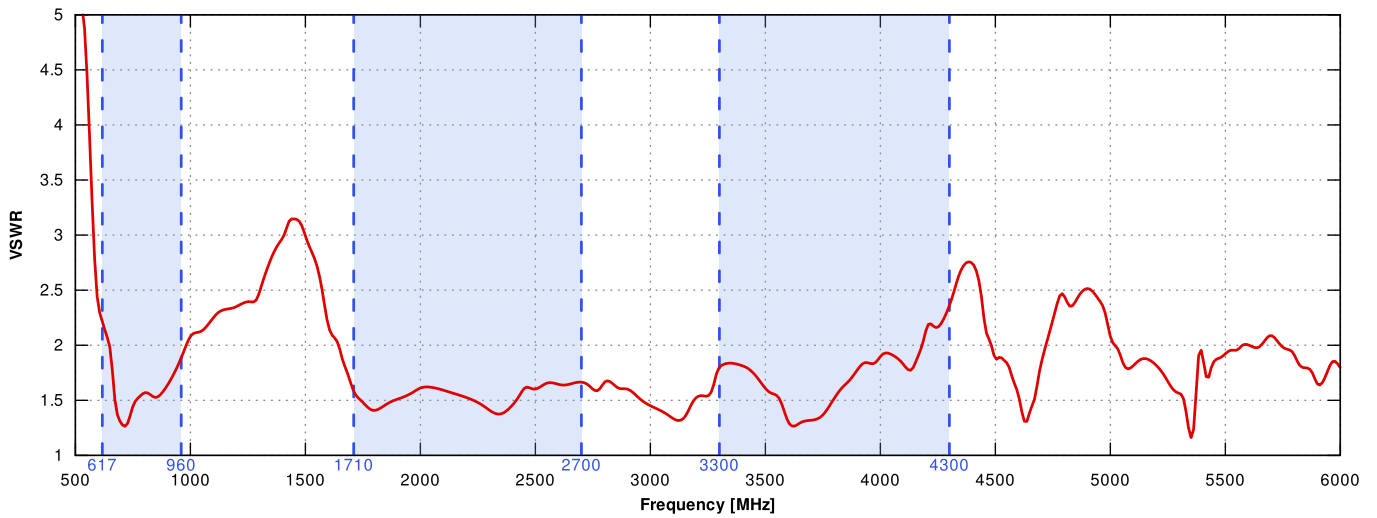

VSWR for Wi-Fi antenna

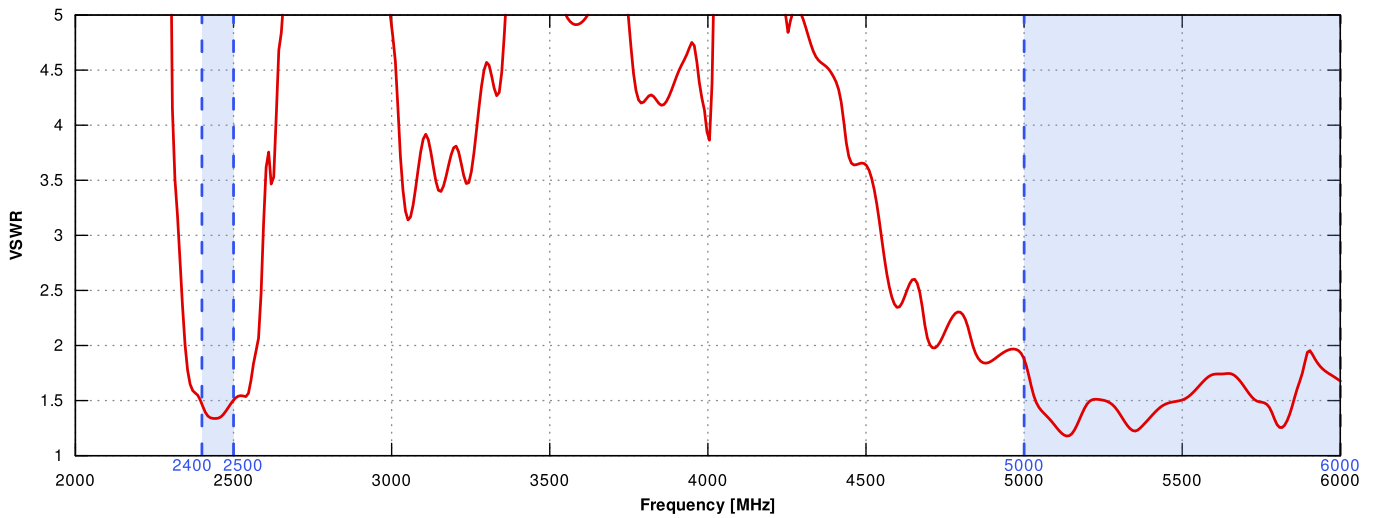

Gain for 5G/LTE antenna

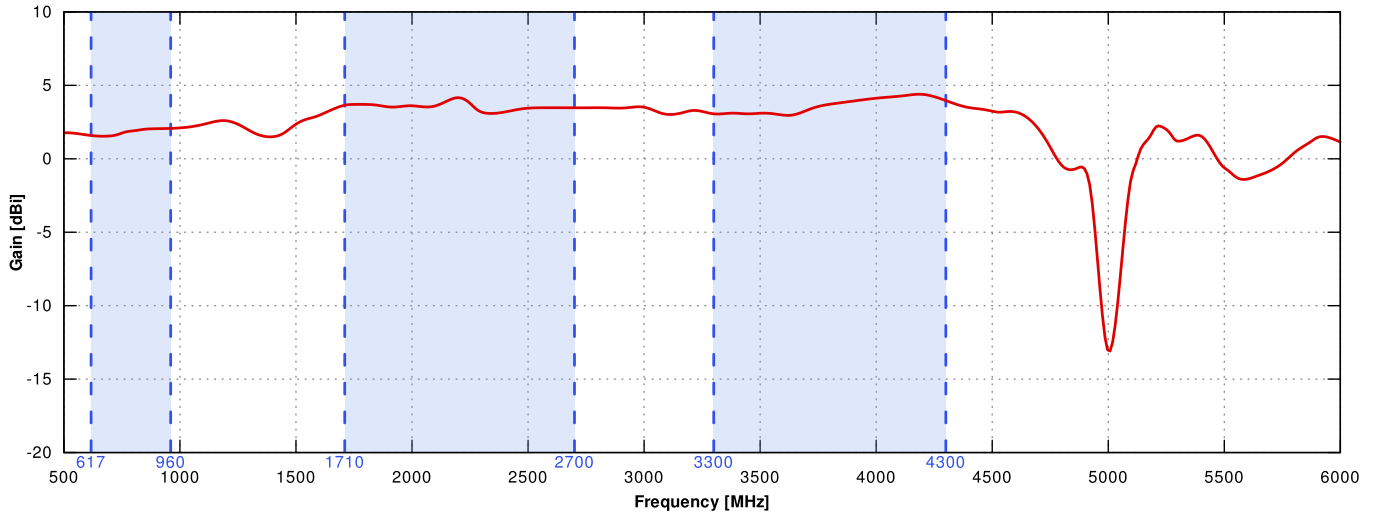

Gain for Wi-Fi antenna

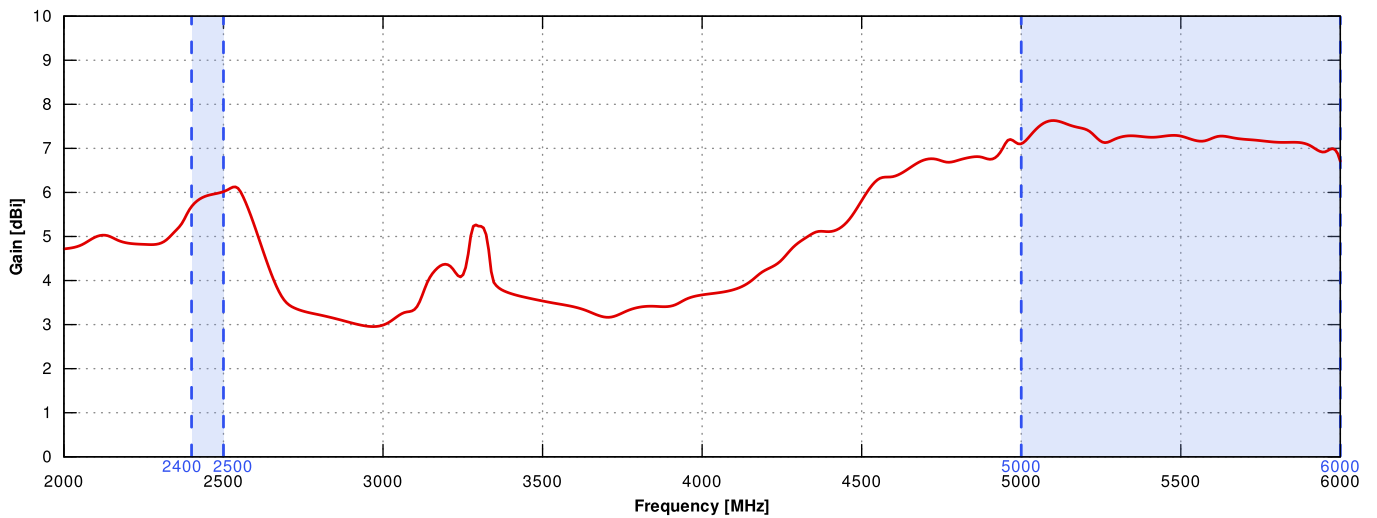

5G/LTE from 617MHz to 960MHz

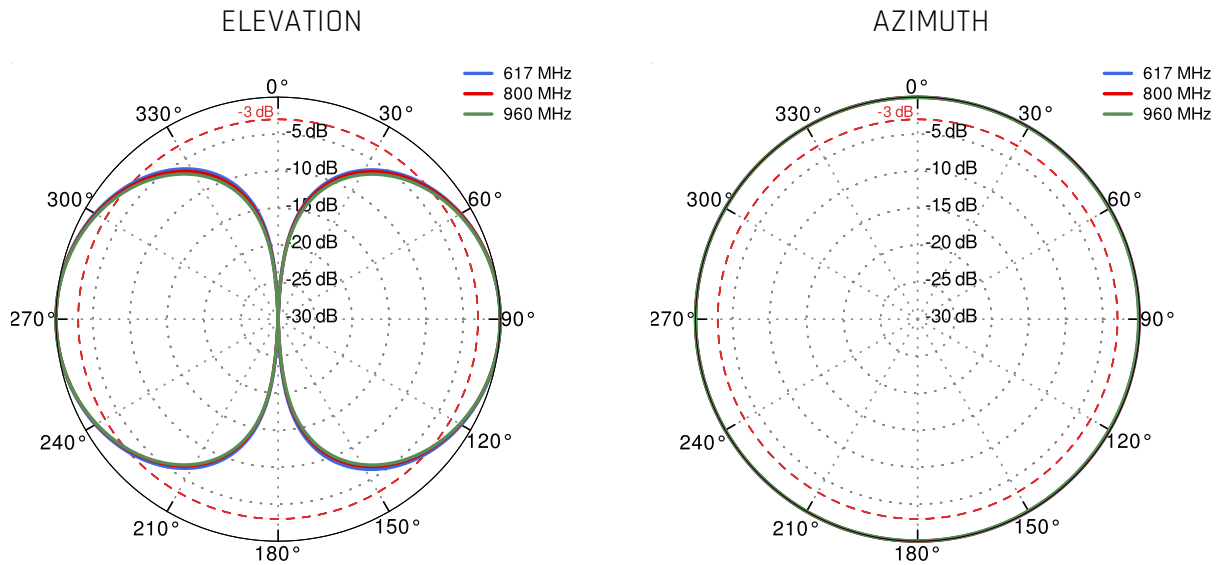

5G/LTE from 1.71GHz to 2.5GHz

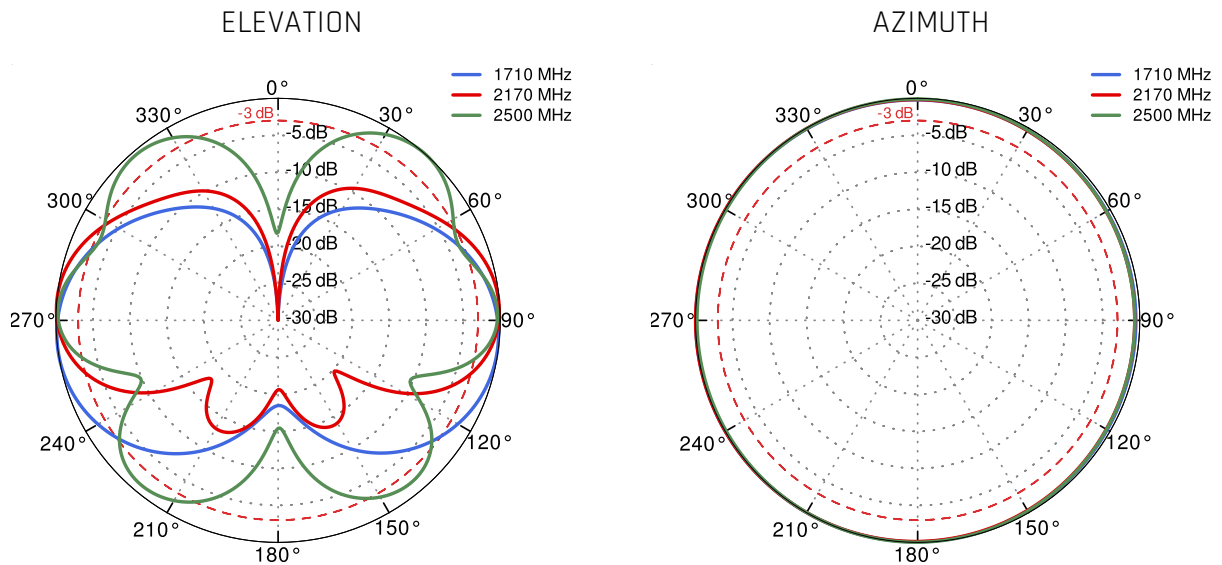

5G/LTE from 3.3GHz to 4.2GHz

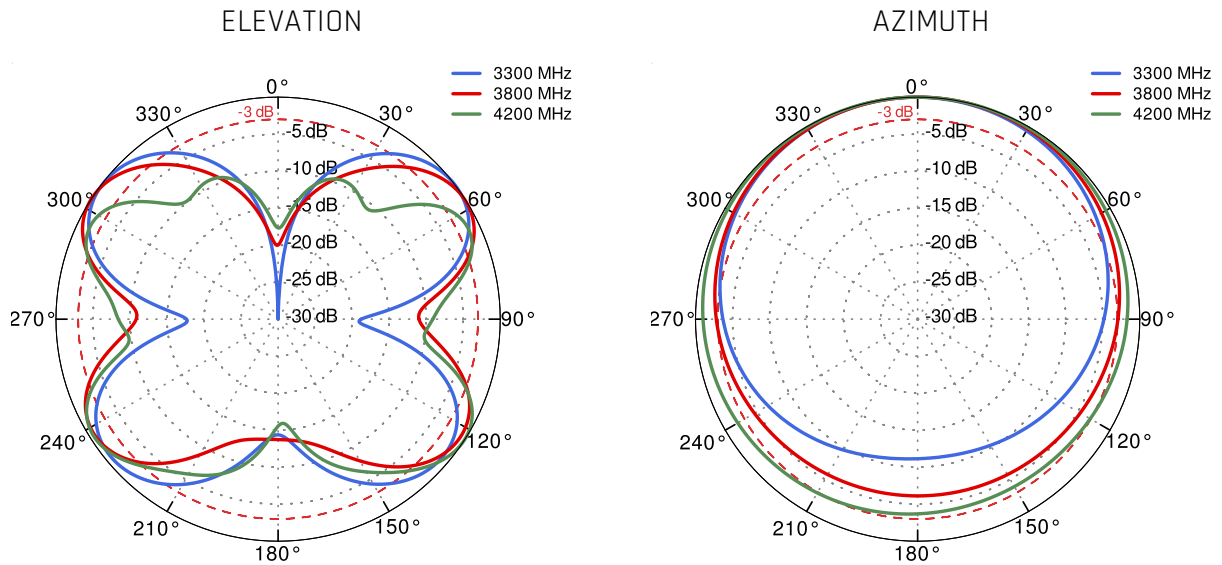

Wi-Fi 2.4 GHz and 5 GHz

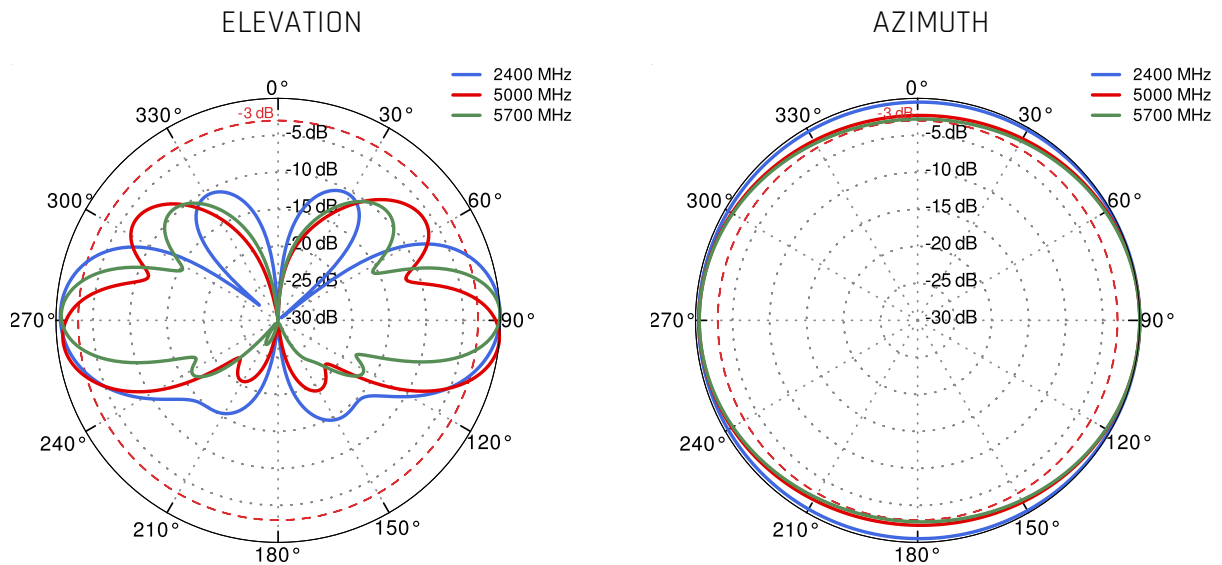

DIMENSIONS

