

**Industrial 1-Port 10/100/1000T Ultra PoE +  
1-Port Coax/UTP Long Reach PoE Injector/Extender**

**LRP-201-KIT**

User's Manual

## **Copyright**

Copyright © 2019 by PLANET Technology Corp. All rights reserved. No part of this publication may be reproduced, transmitted, transcribed, stored in a retrieval system, or translated into any language or computer language, in any form or by any means, electronic, mechanical, magnetic, optical, chemical, manual or otherwise, without the prior written permission of PLANET.

PLANET makes no representations or warranties, either expressed or implied, with respect to the contents hereof and specifically disclaims any warranties, merchantability or fitness for any particular purpose. Any software described in this manual is sold or licensed "as is". Should the programs prove defective following their purchase, the buyer (and not PLANET, its distributor, or its dealer) assumes the entire cost of all necessary servicing, repair, and any incidental or consequential damages resulting from any defect in the software. Further, PLANET reserves the right to revise this publication and to make changes from time to time in the contents hereof without obligation to notify any person of such revision or changes.

All brand and product names mention.

## **Trademarks**

PLANET is a registered trademark of PLANET Technology Corp. All other trademarks belong to their respective owner.

## **Disclaimer**

PLANET Technology does not warrant that the hardware will work properly in all environments and applications, and makes no warranty and representation, either implied or expressed, with respect to the quality, performance, merchantability, or fitness for a particular purpose.

PLANET has made every effort to ensure that this User's Manual is accurate; PLANET disclaims liability for any inaccuracies or omissions that may have occurred. Information in this User's Manual is subject to change without notice and does not represent a commitment on the part of PLANET. PLANET assumes no responsibility for any inaccuracies that may be contained in this User's Manual. PLANET makes no commitment to update or keep current the information in this User's Manual, and reserves the right to make improvements to this User's Manual and/or to the products described in this User's Manual, at any time without notice. If you find information in this manual that is incorrect, misleading, or incomplete, we would appreciate your comments and suggestions.

## FCC Interference Statement

This equipment has been tested and found to comply with the limits for a Class A digital device, pursuant to Part 15 of the FCC Rules. These limits are designed to provide reasonable protection against harmful interference when the equipment is operated in a commercial environment. This equipment generates, uses, and can radiate radio frequency energy and, if not installed and used in accordance with the Instruction manual, may cause harmful interference to radio communications. Operation of this equipment in a residential area is likely to cause harmful interference in which case the user will be required to correct the interference at his own expense.

## CE Mark Warning

This is a Class A product. In a domestic environment, this product may cause radio interference, in which case the user may be required to take adequate measures.

## WEEE Warning



To avoid the potential effects on the environment and human health as a result of the presence of hazardous substances in electrical and electronic equipment, end users of electrical and electronic equipment should understand the meaning of the crossed-out wheeled bin symbol. Do not dispose of WEEE as unsorted municipal waste; WEEE should be collected separately.

## Revision

PLANET Long Reach PoE over Coaxial/UTP Extender Kit User's Manual

**MODELS:** LRP-201HT/LRP-201ET

**REVISION:** 2.1 (August, 2019)

**Part No.:** 2350-AN0150-002

# Table of Contents

1. Introduction .....	5
1.1 Package Contents.....	5
1.2. Introduction of Long Reach Power over Ethernet.....	6
1.3 Product Features .....	6
1.4 Product Specifications .....	7
2. Hardware Description .....	11
2.1 LRP-201HT .....	11
2.1.1 LRP-201HT Physical Dimensions .....	11
2.1.2 LRP-201HT Front Panel and LED Indicators .....	12
2.1.3. LRP-201HT Upper and Bottom Panels .....	13
2.2 LRP-201ET.....	14
2.2.1 LRP-201ET Physical Dimensions .....	14
2.2.2 LRP-201ET Front Panel and LED Indicators.....	15
2.2.3 LRP-201ET Bottom Panel.....	15
3. Installation.....	16
3.1 Installation Precautions of Remote Power by Coaxial cable.....	16
3.2 Installation Precautions of Remote Power by UTP Cable .....	16
3.3 Installation Precautions of Local Power .....	17
3.4 Wiring the Fault Alarm Contact.....	18
3.5 Power options:.....	18
3.6 Applications of LRP-201-KIT with coaxial cable.....	19
3.7 Applications of LRP-201-KIT with UTP/Telephone Wire .....	21
3.8 Mounting Installation .....	24
3.8.1 DIN-rail Mounting .....	24
3.8.2 Wall-mount Plate Mounting .....	25
4. Troubleshooting .....	26
APPENDIX A: Networking Connection.....	27
A.1 Switch's RJ45 Pin Assignments .....	27
A.2 RJ45 Cable Pin Assignments.....	27

## 1. Introduction







Thank you for purchasing PLANET Industrial 1-Port 10/100/1000T Ultra PoE + 1-Port Coax/UTP Long Reach PoE Kit. The descriptions of the two models are as follows:

LRP-201HT	Industrial 1-Port 10/100/1000T Ultra PoE PD + 1-Port Coax/UTP Long Reach PoE Injector
LRP-201ET	Industrial 1-Port 10/100/1000T Ultra PoE + 1-Port Coax/UTP Long Reach PoE Extender

**“Industrial 1-Port 10/100/1000T Ultra PoE + 1-Port Coax/UTP Long Reach PoE Kit”** mentioned in this manual represents the above two models.

### 1.1 Package Contents

Open the box of the Industrial 1-Port 10/100/1000T Ultra PoE + 1-Port Coax/UTP Long Reach PoE Kit and carefully unpack it. The box should contain the following items:

LRP-201-KIT x 1	DIN-rail Kit x 1	Wall-mount Kit x 1	RJ45 Dust Cap x 2
			
User's Manual x 1	Warning Sticker x 1		
			



#### Note

If any item is found missing or damaged, please contact your local reseller for replacement.

## 1.2. Introduction of Long Reach Power over Ethernet

PLANET LRP-201-KIT PoE over Coaxial/UTP Extender is designed to extend IP Ethernet transmission by injecting power over an existing coaxial, UTP or telephone wire for distance up to 600m (1900ft) to PoE IP camera, PoE wireless AP and any 802.3at/bt complied powered device (PD). It is a perfect solution for sending IP video links and power to remotely-installed PoE IP cameras that are beyond the Ethernet 100-meter distance limit.

### Power over Coaxial, UTP or Telephone wire

The Long Reach PoE solution allows Ethernet Data and PoE++ to be transmitted using coaxial, UTP or telephone wire. Based on IEEE 802.3bt Power over Ethernet Plus and up to 60 watts of power output, PLANET Long Reach PoE extender solution eliminates the need for an additional remote electrical outlet as a PoE network switch is enough to provide power to a remotely-installed IP camera via an LRP Extender.

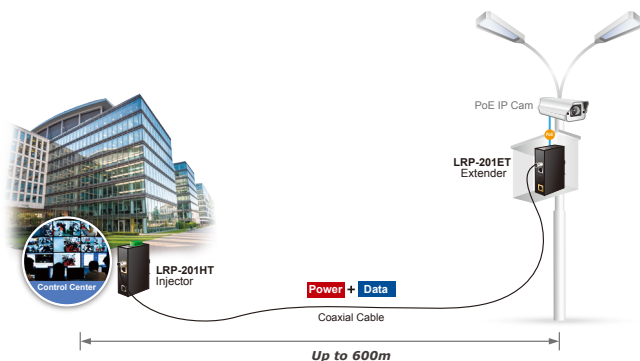

### Stable Operating Performance under Difficult Environments

PLANET Long Reach PoE Extender is the perfect solution for warehouses, parking lots, campuses, casinos, and many more as they require the transmission of data and power over a long distance. They can operate stably under temperature range from -20 to 70 degrees C and thus it can be located in any harsh environment.

## 1.3 Product Features

### Power over Ethernet

- Eliminates Power cabling with PoE over Coaxial
- Supports Power over Ethernet PSE (PoE Injector)

- Power and Ethernet data transmission over coaxial up to 600m
- Power and Ethernet data transmission over UTP up to 400m
- Power and Ethernet data transmission over telephone wire up to 300m
- Complies with IEEE 802.3at/bt Power over Ethernet PD on RJ45 port
- Supports Long Reach PoE power up to 75 watts (depending on power source and cable distance)
- Supports PoE Power up to 60 watts (depending on power source and cable distance)
- Auto detects remote powered device (PD)
- Plug and Play with no configuration required

### Industrial Case and Installation

- Supports extensive LED indicators for network diagnostics
- Metal case
- Compact size; DIN-rail or wall-mount design
- Supports 6KV DC EFT surge protection for power line
- Supports 6KV DC Ethernet ESD protection
- -20 to 70 degrees C operating temperature

## 1.4 Product Specifications

Model		LRP-201HT	LRP-201ET
Functions		Long Reach PoE Injector	Long Reach PoE Extender
Hardware Specifications			
Input Power Terminal Block		Redundant power: 48~54V DC Fault alarm: 1A@24V DC	-
Ethernet Interface	Copper	10/100/1000BASE-T RJ45 Auto-negotiation/Auto-MDI/MDI-X	
	Power over Ethernet Standard	IEEE 802.3at/bt PoE PD	IEEE 802.3at/bt PoE PSE
	PoE Input	Supports both mid-span and end-span PSE Input Range: 48~54V DC	-
	PoE Output	-	56V DC, 1.2A max

Ethernet Interface	PoE Budget	-	Up to 60 watts
	PoE Mode	-	Pair 1 end-span: 1/2 (-), 3/6 (+) Pair 2 mid-span: 4/5 (+), 7/8 (-)
	Data Rate	100/100/1000Mbps	
	Cabling	Cat. 5e or above	
	Maximum Distance	100 meters	
	Maximum Frame sizes	1522bytes	
Long Reach PoE Interface*1	Connectivity	1 x RJ45 female connector Long Reach PoE over UTP PSE 1 x BNC female connector Long Reach PoE over coaxial PSE	1 x RJ45 female Long Reach PoE over UTP PD  1 x BNC female Long Reach PoE over coaxial PD
	Power Input	-	40~54V DC
	Power Output	44~54V DC	-
	Power Pin Assignment	Coaxial <ul style="list-style-type: none"> <li>■ BNC center pole: DC+</li> <li>■ BNC shield: DC-</li> </ul> UTP <ul style="list-style-type: none"> <li>■ RJ45 Pin 1, 3, 5, 7: VCC+</li> <li>■ RJ45 Pin 2, 4, 6, 8: VCC-</li> </ul>	
	Cabling	Coaxial <ul style="list-style-type: none"> <li>■ Coaxial cable: 75 ohm</li> <li>■ RG-6/U cable, less than 12Ω/1000 ft.</li> <li>■ RG-59/U cable, less than 30Ω/1000 ft.</li> </ul> UTP <ul style="list-style-type: none"> <li>■ Cat. 5e/6 UTP cable</li> <li>■ EIA/TIA-568 100-ohm STP</li> </ul>	



Long Reach PoE Interface*1	Maximum Distance	Coaxial - Max. 200m with PoE++ output (656ft.) - Max. 400m with PoE+ output (1312ft.) - Max. 600m with PoE output (1,968ft.) UTP - Max. 100m with PoE++ output (328ft.) - Max. 200m with PoE+ output (656ft.) - Max. 300m with PoE output (984ft.) - Max. 400m with PoE output (1,312ft.)					
	Long Reach Ethernet Standard	IEEE 1901					
	Modulation Type	Wavelet-OFDM					
	Security	128-bit AES encryption					
	Frequency Band	2 ~ 50 MHz					
	Encryption	AES 128-bit					
	Coaxial Performance*2	Distance	Data Rate*3 (Upload / Download)	LRP-201ET 802.3at/bt PoE Output Capability			
				LRP-201HT W/48V DC IN	LRP-201HT W/60W PoE++ IN		
				200m	477/471 Mbps	41W	34W
				400m	239/234 Mbps	16W	22W
	600m	107/98 Mbps	6W	8W			
Multiple Nodes	Supports up to 2 LRP extenders within 0.6km						
LRP Compatibility	LRP-201ET - 1-Port LRP Extender		LRP-201HT - 1-Port LRP Injector				
LED Indicators	<ul style="list-style-type: none"> <li>■ P1</li> <li>■ P2</li> <li>■ FAULT</li> <li>■ PoE Input</li> <li>■ SYS</li> <li>■ PAIR</li> <li>■ PoE IN</li> <li>■ LNK/ACT</li> </ul>		<ul style="list-style-type: none"> <li>■ PWR</li> <li>■ SYS</li> <li>■ PAIR</li> <li>■ PoE-in-Use</li> <li>■ LNK/ACT</li> </ul>				
ESD Protection	6KV DC						
EFT Protection	6KV	-					

Enclosure	Metal case	
Installation	DIN-rail kit or wall-mount ear	
Dimensions (W x D x H)	32 x 87.8 x 135 mm	
Weight	520g	510g
Power Requirements	<ul style="list-style-type: none"> <li>■ RJ45 PoE Input: 802.3at/bt 48~54V DC, 2.5A max.</li> <li>■ DC Input: 48~54V DC, 2.5A max.</li> </ul>	<ul style="list-style-type: none"> <li>■ BNC Power over Coaxial Input: 40~54V DC, 1.8A max.</li> <li>■ RJ45 Power over Ethernet Input: 40~54V DC, 1.8A max.</li> </ul>
Standards Conformance		
Standards Compliance	IEEE 802.3 10BASE-T Ethernet IEEE 802.3u 100BASE-TX Fast Ethernet IEEE 802.3ab 1000BASE-T Gigabit Ethernet IEEE 802.3bt 4-pair Power over Ethernet IEEE 802.3at Power over Ethernet	
Regulatory Compliance	FCC Part 15 Class A, CE	
Environment		
Temperature	Operating: -20~70 degrees C Storage: -30~75 degrees C	
Humidity	Operating: 5~95% (non-condensing) Storage: 5~95% (non-condensing)	

- \*1-1 Please do not connect any Ethernet device to LRP OUT Port of the LRP-201HT; otherwise, it will damage the Ethernet device.
- \*1-2 Please do not connect any Ethernet device to LRP IN Port of the LRP-201ET; otherwise, it will damage the Ethernet device.
- \*2 Depending on what the DC/PoE power input and the length of coaxial/UTP cable are.
- \*3-1 Upload from LRP-201ET to LRP-201HT; download from LRP-201HT to LRP-201ET.
- \*3-2 As there are various resistance values in the category of coaxial/UTP cable, the actual data rate will vary on the quality of the copper wire and environmental factors.

## 2. Hardware Description

### 2.1 LRP-201HT

#### 2.1.1 LRP-201HT Physical Dimensions

- LRP-201HT dimensions (W x D x H): 32 x 87.8 x 135 mm

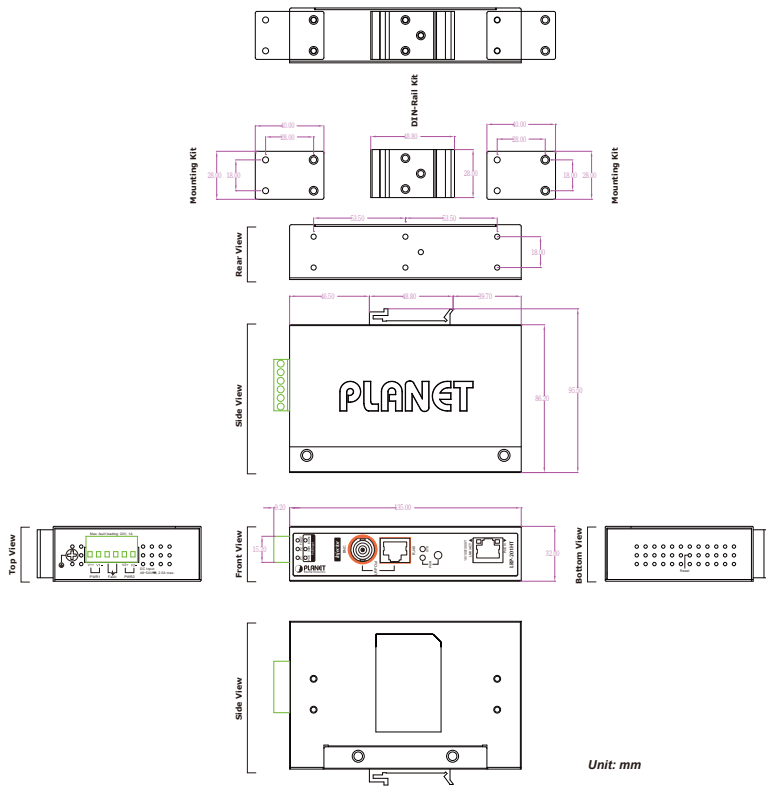

## 2.1.2 LRP-201HT Front Panel and LED Indicators

Figure 2-1 shows the front panels of the LRP-201HT

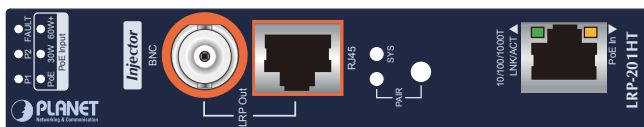

Figure 2-1: LRP-201HT Front Panel

### ➤ System

LED	Color	Function
P1	Green	<b>Lit:</b> Power 1 is active.
		<b>Off:</b> Power 1 is inactive.
P2	Green	<b>Lit:</b> Power 2 is active.
		<b>Off:</b> Power 2 is inactive.
FAULT	Red	<b>Lit:</b> Indicates either power 1 or power 2 has no power.
		<b>Off:</b> No failure.
SYS	Green	<b>Lit:</b> Indicates the system is working.
		<b>Off:</b> Indicates the system is booting.
PAIR	Green	<b>Lit:</b> Indicates the link is working between LRP-201-KIT.
		<b>Off:</b> Indicates the link is inactive.

### ➤ PoE Input

LED	Color	Function
PoE	Green	<b>Lit:</b> Indicates the port is receiving 48~54V DC in-line power and ready for output.
30W	Green	<b>Lit:</b> Indicates the device is working in 802.3at PoE mode.
60W+	Green	<b>Lit:</b> Indicates the device is working in Ultra PoE mode.

➤ **1000Mbps PoE In Slot**

LED	Color	Function
LNK/ ACT	Green	<b>Lit:</b> Indicates the link through that port is successfully established at 10/100/1000Mbps.
		<b>Blinks:</b> Indicates that the Switch is actively sending or receiving data over that port.
PoE In	Orange	<b>Lit:</b> Indicates the RJ45 port is receiving the PoE power.

➤ **Button**

Button	Function
PAIR	Press the PAIR button for 3 seconds to join another LRP extender.
Reset	Hold the Reset button for about 10 seconds until the PAIR and SYS LEDs are off, meaning the device has been reset to default setting.

**2.1.3. LRP-201HT Upper and Bottom Panels**

The upper panel of the LRP-201HT consists of one terminal block connector consisting of two DC power inputs. Figure 2-2 shows the upper panel of the LRP-201HT.

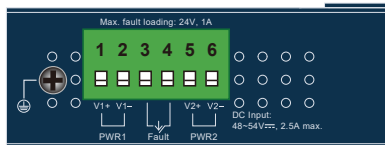

**Figure 2-2:** LRP-201HT Upper Panel

The bottom panel of the LRP-201HT consists of one reset button. Figure 2-3 shows the bottom panel of the LRP-201HT.

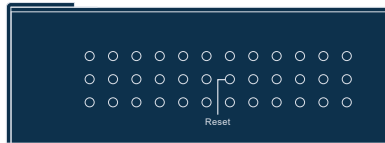
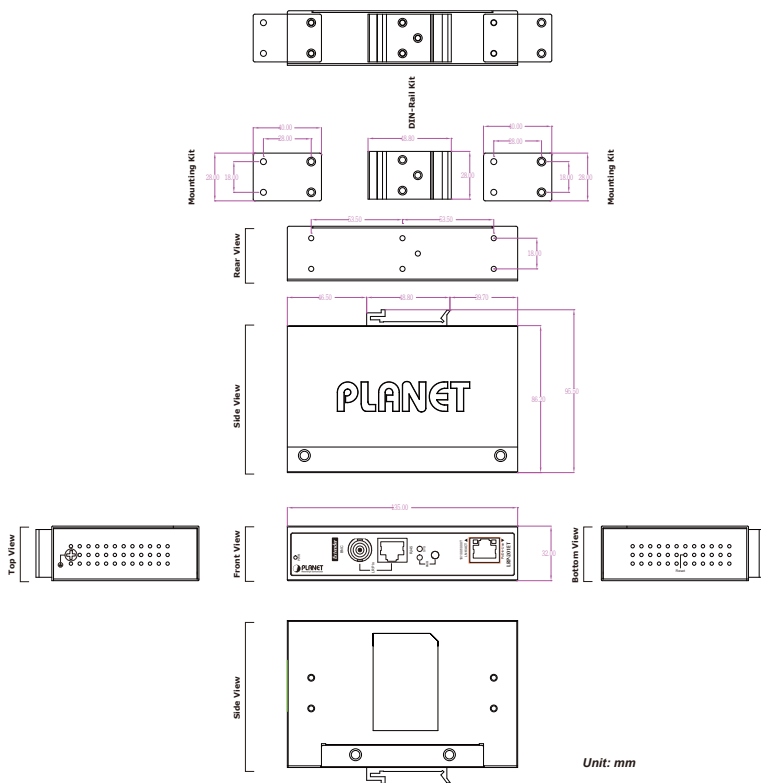

**Figure 2-3:** LRP-201HT Bottom Panel

## 2.2 LRP-201ET

### 2.2.1 LRP-201ET Physical Dimensions

- **LRP-201ET** dimensions (W x D x H): 135 x 87.8 x 32mm



## 2.2.2 LRP-201ET Front Panel and LED Indicators

Figure 2-4 shows the front panel of the LRP-201ET.

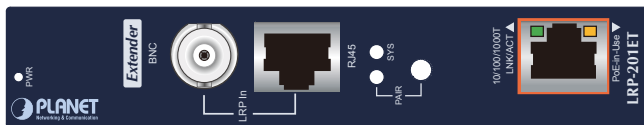

Figure 2-4: LRP-201ET Front Panel

### ➤ System

LED	Color	Function
PWR	Green	<b>Lit:</b> Indicates the power is on.
SYS	Green	<b>Lit:</b> Indicates the system is working.
		<b>Off:</b> Indicates the system is booting.
PAIR	Green	<b>Lit:</b> Indicates the link is working between LRP-201-KIT.
		<b>Off:</b> Indicates the link is inactive.

### ➤ 1000Mbps PoE-in-Use Slot

LED	Color	Function
LNK/ACT	Green	<b>Lit:</b> Indicates the link through that port is successfully established at 10/100/1000Mbps.
		<b>Blinks:</b> Indicates that the Switch is actively sending or receiving data over that port.
PoE-in-Use	Orange	<b>Lit:</b> Indicates the port is providing 56V DC in-line power.

### ➤ Button

Button	Function
PAIR	Press PAIR button during 3 seconds to join another LRP injector.
Reset	Hold the Reset button for about 10 seconds until the PAIR and SYS LEDs are off, meaning the device has been reset to default setting.

## 2.2.3 LRP-201ET Bottom Panel

The reset button is found on the bottom panel of the LRP-201ET where Figure 2-5 shows.

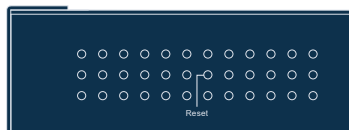

Figure 2-5: LRP-201ET Bottom Panel

### 3. Installation

This section describes the functionalities of the Industrial 1-Port 10/100/1000T Ultra PoE + 1-Port Coax/UTP Long Reach PoE Kit's components and guides you to how to install it on the desktop. Basic knowledge of networking is expected. Please read this chapter completely before continuing.

#### 3.1 Installation Precautions of Remote Power by Coaxial cable

As the LRP-201HT is a power over coaxial injector, it only can work with PLANET power over coaxial extender, the LRP-201ET.

The package contains one Warning Sticker, which should be stuck on the coaxial cable connector before using PLANET Long Reach PoE over Coaxial Extender Kit.

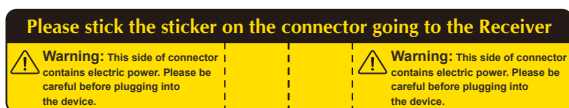

#### 3.2 Installation Precautions of Remote Power by UTP Cable

The LRP-201HT injector, when installed over an UTP cable, can only work with PLANET LRP-201ET extender. Make sure non-PoE devices are not connected to the Ethernet port or else it will cause damage to the devices.



### 3.3 Installation Precautions of Local Power

The 6-contact terminal block connector on the upper panel of LRP injector is used for two DC redundant power inputs. Please follow the steps below to insert the power wire.



#### Note

1. When an external power supply and Ultra PoE switch are connected at the same time, the LRP-201HT will give priority to higher voltage of power source. Both **data** and **power** are then transmitted to the LRP-201ET.
2. If the input voltage is the same as the external power supply and Ultra PoE switch, the power loading will be balanced.



#### Caution

When performing any of the procedures like inserting the wires or tightening the wire-clamp screws, make sure the power is OFF to prevent from getting an electric shock.

1. Insert positive and negative DC power wires into contacts 1 and 2 for POWER 1, or 5 and 6 for POWER 2.

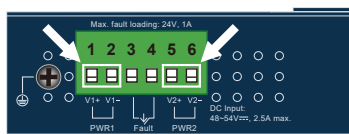

2. Tighten the wire-clamp screws for preventing the wires from loosening.



1	2	3	4	5	6
Power 1		Fault		Power 2	
+	-			+	-



#### Note

1. The wire gauge for the terminal block should be in the range between 12 and 24 AWG.
2. The DC power input range is 48V ~ 54V DC.

### 3.4 Wiring the Fault Alarm Contact

The fault alarm contacts are in the middle of the terminal block connector as the picture shows below. When the wires are inserted, the LRP Extender will detect the fault status of the power failure and then form an open circuit. The following illustration shows an application example for wiring the fault alarm contacts.

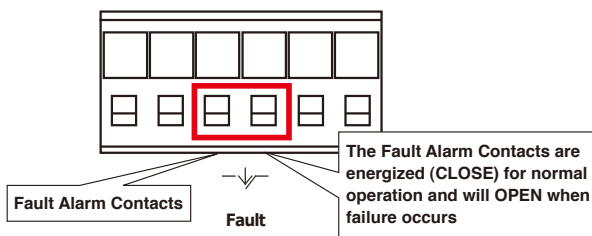

#### Note

1. The wire gauge for the terminal block should be in the range between 12 and 24 AWG.
2. Alarm relay circuit accepts up to 24V, max. 1A currents.

### 3.5 Power options:

#### ■ LRP Injector

There are two ways to power the **LRP Injector** (LRP-201HT):

- Powered via PoE.
- Powered via DC Power Supply.

#### ■ LRP Extender

The **LRP Extender** must be powered by the **LRP Injector**.

- LRP-201ET must be powered by the LRP-201HT over coaxial cable.
- LRP-201ET must be powered by the LRP-201HT over UTP/telephone wire.



#### Caution

Please don't connect the LRP Extender to any PoE PSE (Power Sourcing Equipment).

### 3.6 Applications of LRP-201-KIT with coaxial cable

**Type 1:** One LRP-201HT with PoE power input and one LRP-201ET with PoE power output

The LRP Injector is powered via IEEE 802.3at/bt PoE. An IEEE 802.3at/bt compliant PoE PD will automatically be powered by the LRP Extender via UTP.

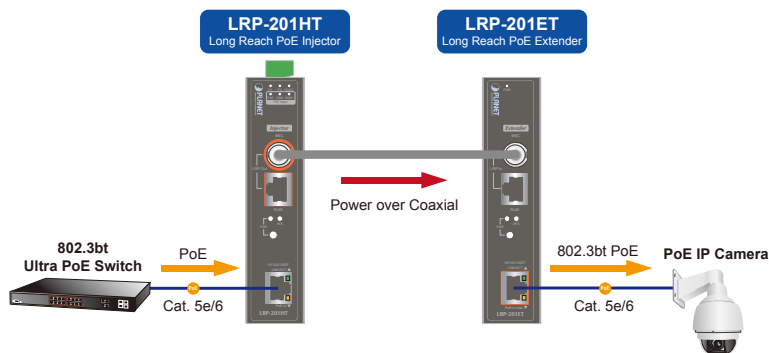

Functions	LRP Injector	LRP Extender
	LRP-201HT	LRP-201ET
Power Input	RJ45 with 802.3at/bt PoE input	BNC with DC power over coaxial input
Power Output	BNC with DC power over coaxial output	RJ45 with 802.3at/bt PoE output

#### Installation Instructions

- Step 1:** Connect the LRP Injector (LRP-201HT) and LRP Extender (LRP-201ET) to ends of BNC terminated coaxial cable. Stick the "Warning Sticker" on the coaxial cable.
- Step 2:** Connect Cat. 5e/6 UTP cable to LRP-201HT and IEEE 802.3bt compliant PoE Switch or PoE Injector. If the PoE switch or PoE injector is powered on already, then the PWR LED of LRP-201HT and LRP-201ET should light up immediately.
- Step 3:** Connect Cat. 5e/6 UTP cable to LRP-201ET and IEEE 802.3at/bt complied PoE IP camera or PoE Wireless AP.



The LRP-201HT accepts IEEE 802.3bt device for optimal power injection. The other non-standard PoE power devices may cause the LRP-201HT to malfunction.



## Note

1. Before installation, please consider the distance and watts value demand for PD devices. The LRP-201-KIT PoE output capacity and upload / download performance depend on the length of coaxial cable.
2. As there are various resistance values in the category of RG-59/U or RG-6/U cable, the actual data rate will vary on the quality of the copper wire and environmental factors.

**Type 2:** One LRP-201HT with 48~54V power adapter and one LRP-201ET with PoE power output

The **LRP Injector** is powered via the external power adapter. The IEEE 802.3at/bt compliant PoE PD will automatically be powered by the **LRP Extender** via UTP.

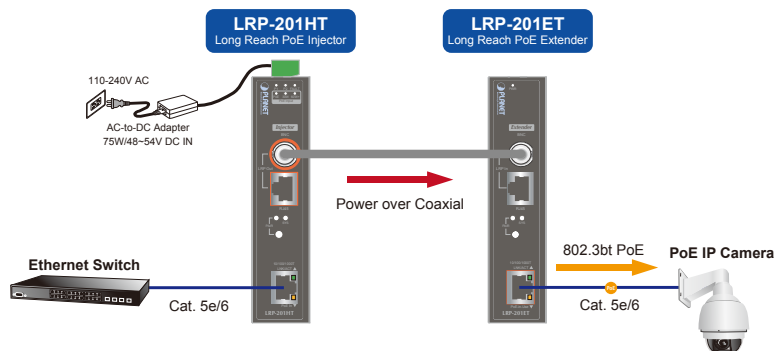

Functions	LRP Injector	LRP Extender
	LRP-201HT	LRP-201ET
Power Input	<b>Power adapter</b> with <b>48~54V DC</b> in	<b>BNC</b> with DC power over coaxial input
Power Output	<b>BNC</b> with DC power over coaxial output	<b>RJ45</b> with 802.3at/bt PoE output

## Installation Instructions

- Step 1:** Connect the LRP Injector (LRP-201HT) and LRP Extender (LRP-201ET) to ends of BNC terminated coaxial cable.  
Stick the "Warning Sticker" on the coaxial cable.
- Step 2:** Connect Cat. 5e/6 UTP cable to LRP-201HT and non-PoE switch or workstation.

**Step 3:** Connect 48~54V DC power adapter to LRP-201HT power socket, then the PWR LED of LRP-201HT and LRP-201ET should light up immediately.

**Step 4:** Connect Cat. 5e/6 UTP cable to LRP-201ET and IEEE 802.3at/bt complied PoE IP camera or PoE wireless AP..



1. Before installation, please consider the distance and watts value demand for PD devices. The LRP-201-KIT PoE output capacity and upload / download performance depend on the length of coaxial cable.
2. As there are various resistance values in the category of RG-59/U or RG-6/U cable, the actual data rate will vary on the quality of the copper wire and environmental factors.
3. PoE output capacity is based on different DC Power Input / PoE Input.

### 3.7 Applications of LRP-201-KIT with UTP/Telephone Wire

**Type 1:** LRP-201HT with PoE power input and LRP-201ET with PoE power output

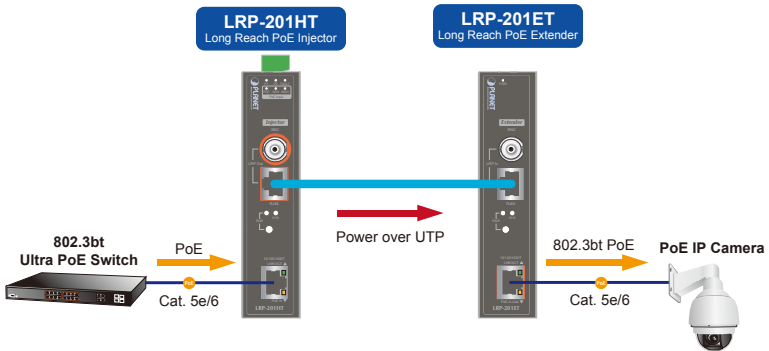

Functions	LRP Injector	LRP Extender
	LRP-201HT	LRP-201ET
Power Input	<b>RJ45</b> with <b>802.3at/bt</b> PoE input	<b>UTP</b> with DC power over UTP input
Power Output	<b>UTP</b> with DC power over UTP output	<b>RJ45</b> with <b>802.3at/bt</b> PoE output

## Installation Instructions

**Step 1:** Remove the “**Danger – No Ethernet**” labels stuck on the RJ45 LRP port of LRP-201HT and LRP-201ET.

**Step 2:** Connect the LRP Injector (LRP-201HT) and LRP Extender (LRP-201ET) to ends of RJ45 terminated long UTP/telephone wire cable.



Warning

1. Please do not connect any Ethernet device to LRP OUT Port of the LRP-201HT; otherwise, it will damage the Ethernet device.
2. Please do not connect any Ethernet device to LRP IN Port of the LRP-201ET; otherwise, it will damage the Ethernet device.

**Step 3:** Connect Cat. 5e/6 UTP cable to LRP-201HT and IEEE 802.3bt compliant PoE Switch or PoE Injector. If the PoE switch or PoE injector is powered on already, then the PWR LED of LRP-201HT and LRP-201ET should light up accordingly.

**Step 4:** Connect Cat. 5e/6 UTP cable to LRP-201ET and IEEE 802.3at/bt complied PoE IP camera or PoE wireless AP.



Warning

The LRP-201HT accepts IEEE 802.3bt equipment for optimal power injection. The other non-standard PoE Power devices may cause the LRP-201HT to malfunction.



Note

1. Before installation, please consider the distance and watts value demand for PD devices. The LRP-201-KIT PoE output capacity and upload / download performance depend on the length of UTP cable.
2. As there are various resistance values in the UTP/telephone wire, the actual data rate will vary on the quality of the copper wire and environmental factors.

**Type 2:** LRP-201HT with 48~54V power adapter and LRP-201ET with PoE power output

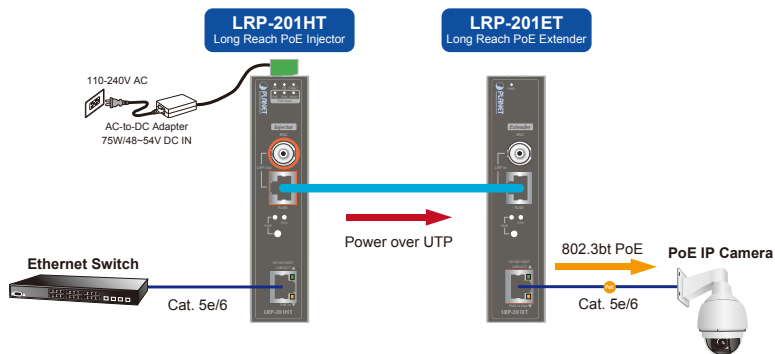

Functions	LRP Injector	LRP Extender
	LRP-201HT	LRP-201ET
Power Input	<b>Power adapter with 48~54V DC in</b>	UTP with DC power over UTP input
Power Output	UTP with DC power over UTP output	<b>RJ45 with 802.3at/bt PoE output</b>

### Installation Instructions

**Step 1:** Remove the "Danger – No Ethernet" labels stuck on the RJ45 LRP ports of LRP-201HT and LRP-201ET.

**Step 2:** Connect the LRP Injector (LRP-201HT) and LRP Extender (LRP-201ET) to ends of RJ45 long UTP/telephone wire.



1. Please do not connect any Ethernet device to LRP OUT Port of the LRP-201HT; otherwise, it will damage the Ethernet device.
2. Please do not connect any Ethernet device to LRP IN Port of the LRP-201ET; otherwise, it will damage the Ethernet device.

**Step 3:** Connect Cat. 5e/6 UTP cable to LRP-201HT and non-PoE switch or workstation.

**Step 4:** Connect 48~54V DC power adapter to LRP-201HT power socket, and then the PWR LED of LRP-201HT and LRP-201ET should light up immediately.

**Step 5:** Connect Cat. 5e/6 UTP cable to LRP-201ET and IEEE 802.3at/bt complied PoE IP camera or PoE Wireless AP.



## Note

1. Before installation, please consider the distance and watts value demand for PD devices. The LRP-201-KIT PoE output capacity and upload / download performance depend on the length of UTP cable.
2. As there are various resistance values in the UTP/telephone wire, the actual data rate will vary on the quality of the copper wire and environmental factors.
3. PoE output capacity is based on different DC Power Input / PoE Input.

## 3.8 Mounting Installation

### 3.8.1 DIN-rail Mounting

The DIN-rail bracket is screwed on the Industrial Ethernet Extender when out of factory. Please refer to following figures to hang the Industrial Ethernet Extender on track.

**Step 1:** Hook the upper DIN-rail bracket on to the track.



**Step 2:** Get the lower DIN-rail bracket snapped into the track.



**Step 3:** Reverse the procedure to remove the Industrial Ethernet Extender from the track.





**Step 4:** Lightly pull out the lower DIN-rail bracket first and lift it up to remove it from the track.

### 3.8.2 Wall-mount Plate Mounting

To install the Industrial Ethernet Extender on the wall, please follow the instructions described below.

**Step 1:** Remove the DIN-rail bracket from the Industrial Ethernet Extender by loosening the screws.



**Step 2:** Place the wall-mount plate on the rear panel of the Industrial Ethernet Extender.

**Step 3:** Use the screws to screw the wall-mount plate on the Industrial Ethernet Extender.

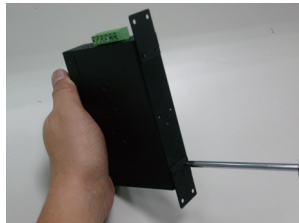

**Step 4:** Use the hook holes at the corners of the wall-mount plate to hang the Industrial Ethernet Extender on the wall.

**Step 5:** To remove the wall-mount plate, reverse the steps above.

## 4. Troubleshooting

This chapter contains information to help you solve issues. If the Long Reach PoE over Coaxial/UTP Extender Kit is not functioning properly, make sure the Long Reach PoE over Coaxial/UTP Extender Kit is set up according to instructions in this manual.

### **The power sources that can be accepted by LRP-201HT are:**

1. DC 54V power adapter.
2. DC 48V power adapter.
3. IEEE 802.3bt Ultra Power over Ethernet Switch.
4. IEEE 802.3at High Power over Ethernet Switch.

### **The LRP-201HT's and LRP-201ET's performances are bad.**

#### **Answer:**

The actual data rate will vary on the quality of the coaxial/UTP cable and environmental factors. It is recommended to use a high-quality coaxial/UTP cable, and its length must not exceed its spec. distance.

## 5. Customer Support

Thank you for purchasing PLANET products. You can browse our online FAQ resource at the PLANET Web site first to check if it could solve your issue. If you need more support information, please contact PLANET support team.

PLANET online FAQs:

<http://www.planet.com.tw/en/support/faq?method=category&c1=2>

Support team mail address:

[support@planet.com.tw](mailto:support@planet.com.tw)

Copyright © PLANET Technology Corp. 2019.

Contents are subject to revision without prior notice.

PLANET is a registered trademark of PLANET Technology Corp.

All other trademarks belong to their respective owners.

## APPENDIX A: Networking Connection

### A.1 Switch's RJ45 Pin Assignments

1000Mbps, 1000BASE-T

PIN NO	MDI	MDI-X
1	BI_DA+	BI_DB+
2	BI_DA-	BI_DB-
3	BI_DB+	BI_DA+
4	BI_DC+	BI_DD+
5	BI_DC-	BI_DD-
6	BI_DB-	BI_DA-
7	BI_DD+	BI_DC+
8	BI_DD-	BI_DC-

### A.2 RJ45 Cable Pin Assignments

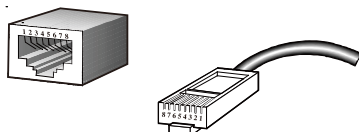

The standard RJ45 receptacle/connector

There are 8 wires on a standard UTP/STP cable and each wire is color-coded. The following shows the pin allocation and color of straight-through cable and crossover cable connection:

<u>Straight-through Cable</u>		<u>SIDE 1</u>	<u>SIDE 2</u>
1	2	1 = White/Orange	1 = White/Orange
2	3	2 = Orange	2 = Orange
3	4	3 = White/Green	3 = White/Green
4	5	4 = Blue	4 = Blue
5	6	5 = White/Blue	5 = White/Blue
6	7	6 = Green	6 = Green
7	8	7 = White/Brown	7 = White/Brown
8		8 = Brown	8 = Brown

---

<u>Cross Over Cable</u>		<u>SIDE 1</u>	<u>SIDE 2</u>
1	2	1 = White/Orange	1 = White/Green
2	3	2 = Orange	2 = Green
3	4	3 = White/Green	3 = White/Orange
4	5	4 = Blue	4 = Blue
5	6	5 = White/Blue	5 = White/Blue
6	7	6 = Green	6 = Orange
7	8	7 = White/Brown	7 = White/Brown
8		8 = Brown	8 = Brown

Figure A-1: Straight-through and Crossover Cable

Please make sure your connected cables are with the same pin assignment and color as the above picture before deploying the cables into your network.

## EC Declaration of Conformity

For the following equipment:

\*Type of Product: Industrial 1-Port 10/100/1000T Ultra PoE + 1-Port Coax/UTP Long Reach PoE Extender  
Industrial 1-Port 10/100/1000T Ultra PoE PD + 1-Port Coax/UTP Long Reach PoE Injector

\*Model Number: LRP-201ET/LRP-201HT

\* Produced by:

Manufacturer's Name : **Planet Technology Corp.**

Manufacturer's Address: 10F., No.96, Minquan Rd., Xindian Dist., New Taipei City 231, Taiwan

is herewith confirmed to comply with the requirements set out in the Council Directive on the Approximation of the Laws of the Member States relating to Electromagnetic Compatibility Directive on (2014/30/EU).

For the evaluation regarding the EMC, the following standards were applied:

EN 55032	(2015)
EN61000-3-2	(2014)
EN61000-3-3	(2013)
EN 55024	(2010)

Responsible for marking this declaration if the:

Manufacturer  Authorized representative established within the EU

Authorized representative established within the EU (if applicable):

Company Name: Planet Technology Corp.

Company Address: 10F., No.96, Minquan Rd., Xindian Dist., New Taipei City 231, Taiwan

Person responsible for making this declaration

Name, Surname Kent Kang

Position / Title : Director

Taiwan  
Place

May 21, 2018  
Date

  
Legal Signature

### **PLANET TECHNOLOGY CORPORATION**

e-mail: sales@planet.com.tw http://www.planet.com.tw

10F., No.96, Minquan Rd., Xindian Dist., New Taipei City, Taiwan, R.O.C. Tel:886-2-2219-9518 Fax:886-2-2219-9528