

19" EINTEILIGER WANDVERTEILERSCHRANK, PRO 2nd GENERATION

WCAB PS2 600X600 (B)

BESCHREIBUNG

- Wirewin® 19" einteiliger Wandverteilerschrank
- Glastür, versperrbar
- abnehmbare Seitenteile mit speziellen verdeckten Feder-Stiftsystem
- 2 Paar 19" Schienen
- die vorderen Schienen sind verstellbar, die hinteren Schienen sind fest
- 600 mm Breite
- 600 mm Tiefe, 450 mm verfügbar
- 4HE / 6HE / 9HE / 12HE / 15HE / 18HE / 21HE Höhen
- getestet bis 100 kg Belastung



Spezifikationen:

- Material:
- Hauptkörper (Struktur):
DIN EN 10130-DC-01-6112 CRS, 0,8 mm
 - Glastüre:
EN 12150-1 gehärtetes Sicherheitsglas, 4,0 mm
 - 19" Gerätemontageschienen:
DIN EN 10130-DC-01-6112 CRS, 1,2 mm
 - Hinterer Gehäuserahmen:
DIN EN 10130-DC-01-6112 CRS, 1,0 mm
 - Seitenteile:
DIN EN 10130-DC-01-6112 CRS, 0,8 mm

- Farbe:
- RAL7035, Hellgrau oder RAL9005 Schwarz

- max. Belastung:
- 100 kg Belastung getestet

- Verpackung:
- einzeln, Kartonverpackung, montiert

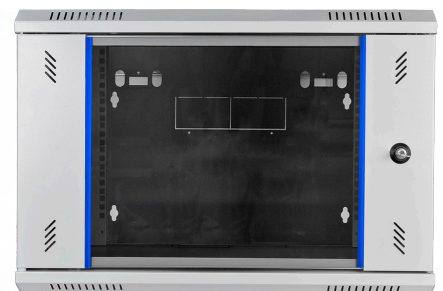

FARBE: RAL7035, HELLGRAU

HE	ARTIKELNUMMER	BREITE	TIEFE	HÖHE	GEWICHT	EAN NUMMER	V-GEWICHT	VERSANDGRÖSSE
4HE	WCAB PS2 600X600X4U	600	600	278	13,4 kg	9120072487354	15,8 kg	635 x 655 x 292
6HE	WCAB PS2 600X600X6U	600	600	367	15,4 kg	9120072487361	17,8 kg	635 x 655 x 382
9HE	WCAB PS2 600X600X9U	600	600	500	18,0 kg	9120072487385	20,4 kg	635 x 655 x 514
12HE	WCAB PS2 600X600X12U	600	600	633	21,8 kg	9120072487408	24,5 kg	635 x 655 x 677
15HE	WCAB PS2 600X600X15U	600	600	767	26,2 kg	9120072487422	28,9 kg	635 x 655 x 791
18HE	WCAB PS2 600X600X18U	600	600	900	27,6 kg	9120072487446	30,3 kg	635 x 655 x 914
21HE	WCAB PS2 600X600X21U	600	600	1033	30,6 kg	9120072487460	33,6 kg	635 x 655 x 1047

FARBE: RAL9005, SCHWARZ

HE	ARTIKELNUMMER	BREITE	TIEFE	HÖHE	GEWICHT	EAN NUMMER	V-GEWICHT	VERSANDGRÖSSE
4HE	WCAB PS2 600X600X4U B	600	600	278	13,4 kg	9120072487484	15,8 kg	635 x 655 x 292
6HE	WCAB PS2 600X600X6U B	600	600	367	15,4 kg	9120072487491	17,8 kg	635 x 655 x 382
9HE	WCAB PS2 600X600X9U B	600	600	500	18,0 kg	9120072487507	20,4 kg	635 x 655 x 514
12HE	WCAB PS2 600X600X12U B	600	600	633	21,8 kg	9120072487521	24,5 kg	635 x 655 x 677
15HE	WCAB PS2 600X600X15U B	600	600	767	26,2 kg	9120072487545	28,9 kg	635 x 655 x 791
18HE	WCAB PS2 600X600X18U B	600	600	900	27,6 kg	9120072487552	30,3 kg	635 x 655 x 914
21HE	WCAB PS2 600X600X21U B	600	600	1033	30,6 kg	9120072487576	33,6 kg	635 x 655 x 1047

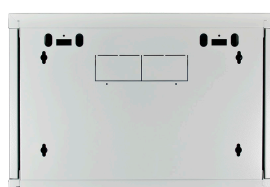
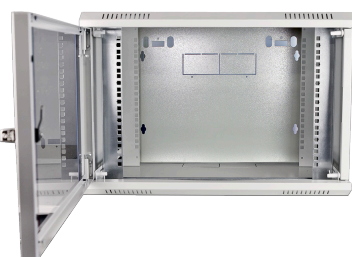

19" EINTEILIGER WANDVERTEILERSCHRANK, PRO 2nd GENERATION

WCAB PS2 600X600 (B)

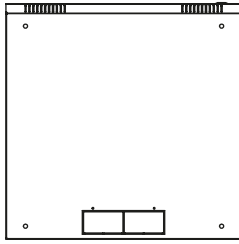

BOTTOM VIEW

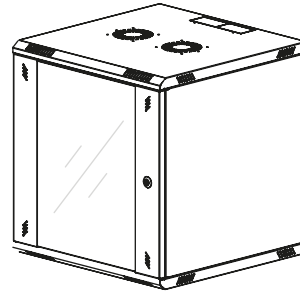

ISOMETRIC VIEW

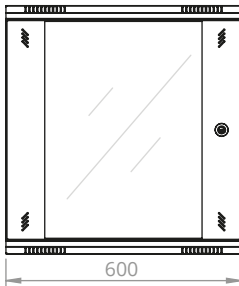

FRONT VIEW

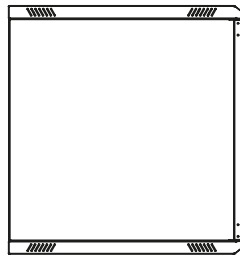

SIDE VIEW

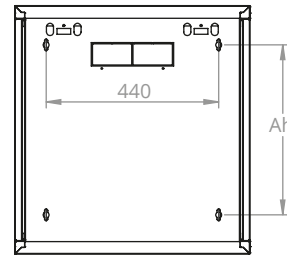

REAR VIEW

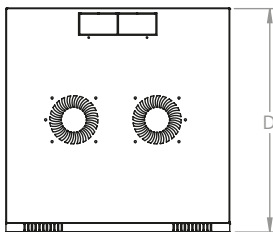

TOP VIEW

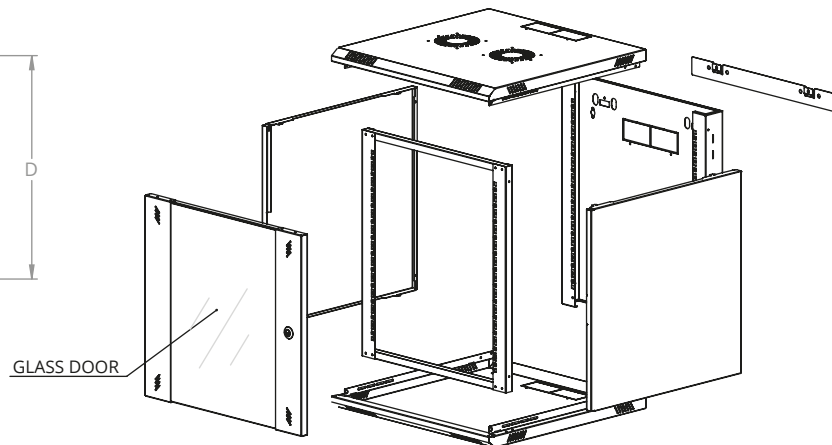

EXPLODED VIEW

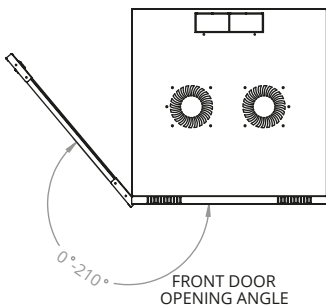

FRONT DOOR
OPENING ANGLE

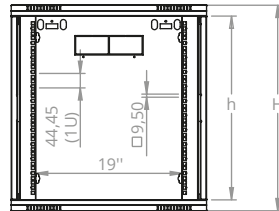

DIMENSIS IN
WITDH AND HEIGHT

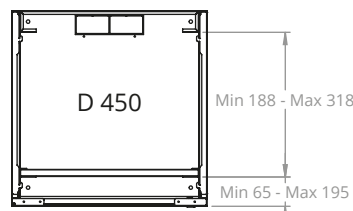

MAX/ MIN EQUIPMENT
MOUNTING DISTANCE
(450)

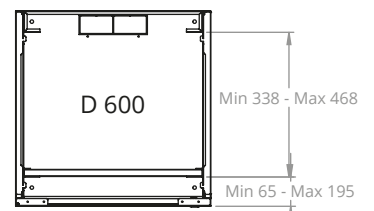

MAX/ MIN EQUIPMENT
MOUNTING DISTANCE
(600)

HE	Ah	h	H	D
4HE	78	210	278	600 / 450
6HE	167	299	367	600 / 450
9HE	301	432	500	600 / 450
12HE	434	565	633	600 / 450
15HE	567	698	766	600 / 450
18HE	700	832	900	600 / 450
21HE	834	934	1033	600 / 450