

MTP® PRO Connector

The MTP® PRO connector is the newest addition to the US Conec MTP® brand MPO product family. This state-of-the-art connector brings simplified use to the MPO format by offering optimal field flexibility and enhanced performance, all while leveraging the proven features and technology of US Conec's MTP® connectors. With a novel design focused on simplicity and reliability, the MTP® PRO connector offers quick and effective polarity and pin reconfiguration in the field while ensuring product integrity and performance.

Features:

- **Field pin change**
Field friendly configuration while maintaining product integrity, fail safe handling of pins and easy color identification
- **Field polarity change**
Simple one-step color coded polarity change feature without removing connector housing
- **Debris reduction system**
Geometry and material optimized to reduce debris generation
- **Integrated push-pull functionality**
Robust push-pull insertion and extraction via the integrated push-pull sleeve or push-pull boot
- **Environmentally friendly**
RoHS and REACH compliant without exemptions

Field Pin Change

Simple and Failsafe Pin Change

US Conec's MTP® PRO design is focused on simplicity and reliability to ensure a quick and effective method for pin configuration without the need to remove the housing or handle loose pins.

- Robust tool for easy pin change process
- Factory color designated pin clamp for easy identification
- Reusable color designated pin exchanger for safe handling of pins
- Field friendly configuration with no risk for damage
- Reliable pin retention force exceeding IEC requirement of 19.6N
- No handling of loose pins
- No housing removal necessary

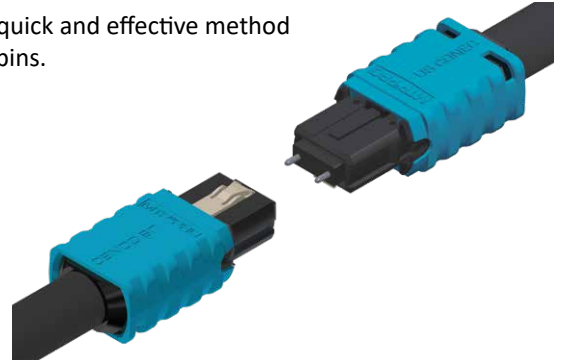

Field Pin ID Color Code

Color	Description
Aqua	MM Elite from factory
Yellow	SM Elite from factory
Black	Female from factory

Pin Exchanger :

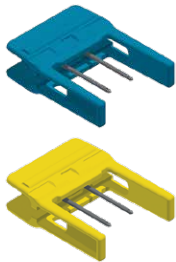

Pin Clamp Color Identification:

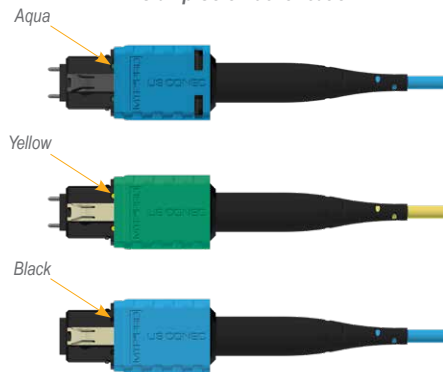

MTP® PRO Pin Change Tool

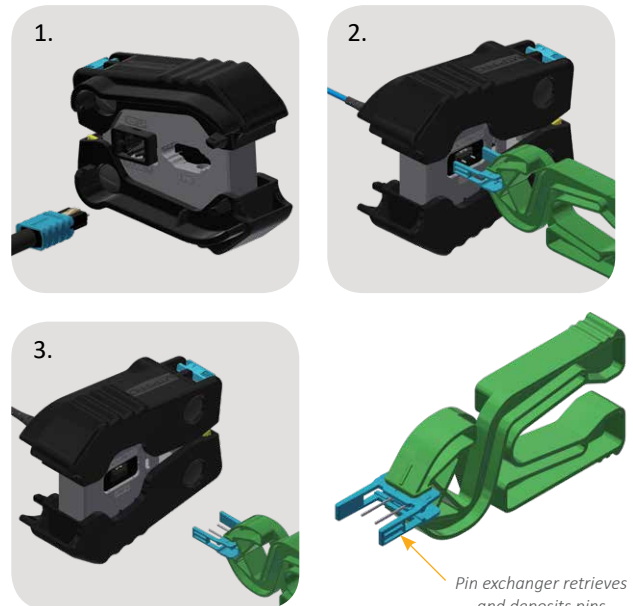

Why Change Pins?

A mated MPO connector pair by definition requires one side to be 'pinned' while the other side is 'unpinned'. While the MPO format is the standardized multi-fiber optical interconnect in data center structured cabling applications, there are no normative requirements for when cables are to be pinned or unpinned. The rule of thumb informative guidance is that the connector side most likely to remain stationary behind a panel or within an enclosure should be pinned when possible. Without a normative requirement and the potential for multiple demarcation points within a given backbone infrastructure, the possibilities for encountering pinned or unpinned MPOs in the data center are endless.

Logistical Simplification = Cost Savings

With no standard for pinned vs. unpinned MPO connectors in structured cabling, it can be difficult to know which method or connectors may be encountered. Pin configurability in the field saves time, eliminates costly errors, requires less pre-planning, and less cabling inventory resulting in a total lower cost cabling infrastructure.

Network Migration

Recent widespread usage of multichannel Tx/Rx links for 40G (QSFP) and 100G (QSFP28) has brought on a new set of challenges with regard to whether or not the MPO should be pinned. For trunk cable applications, the MPO inside of breakout module is typically pinned per the rule of thumb guidance. Subsequently, a single trunk backbone is typically unpinned on each end. However, the parallel module Tx/Rx standard requires pins in the active device. This complicates the need to have simple, like-ended equipment patch cords when duplex Tx/Rx links are upgraded to higher bandwidth, MPO based devices facilitating the need to reconfigure the trunk or backbone cables.

Example of Network Migration

Traditional Structured Cabling Link:
SFP devices with MTP® trunk cables

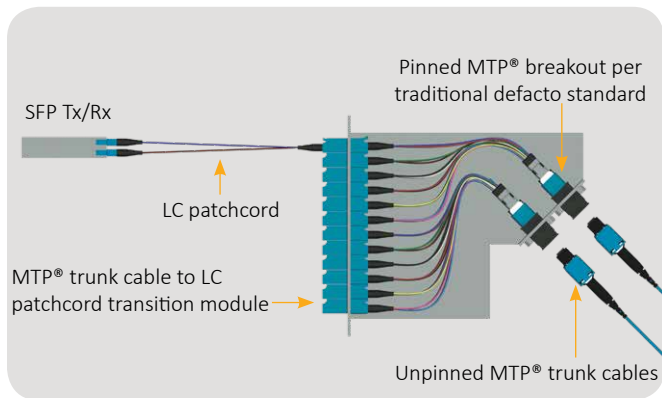

Network Upgrade/Migration:
Upgrade to QSFP devices

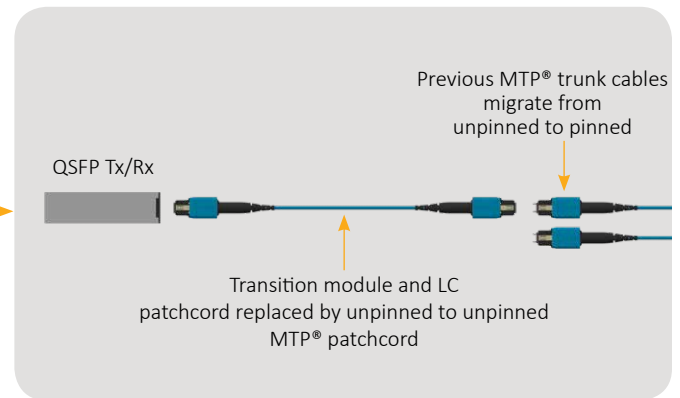

Female to Female patch cord requires trunk to change from unpinned to pinned

MPO History Not to Be Repeated: Pin Transfer

Simple pin change in the field demands that the housing not be removed, exposing delicate fibers which could be broken during the process costing time and money to reorder a custom configured cable. This means the guide pins must come in and out from the front of the connector.

In the 1990's when the MPO connector was released, plastic components were used to secure the guide pins in place. One of the early problems with the MPO format was transfer and subsequent loss of guide pins when MPO plugs were mated and unmated. Friction due to debris in the guide pin hole of an unpinned connector can easily exert a force greater than 10N on a guide pin during connector extraction. Holding the pins in place with a force greater than those frictional forces exerted during function is not trivial. Plastic 'pin keepers' were simply found to be inadequate.

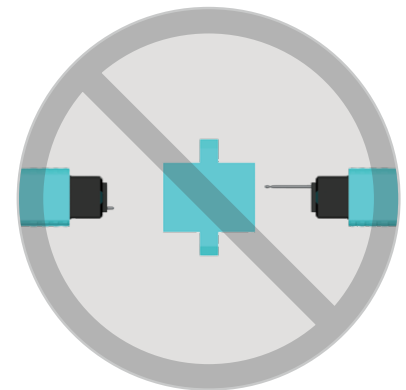

Part of the MTP® development cycle was to eliminate issues associated with the basic MPO format. US Conec's metal pin keeper design eliminated all concerns for 'pin transfer'. Time has passed. Things are forgotten. We cannot go backward. Taking pins in and out from the front of the connector means that when they are put in place, they must stay in place.

Eliminating Pin Transfer

As we learned in the past, plastic pin keeper components simply don't have enough structure to adequately hold the 700µm MT guide pins in place. US Conec novel pin keeper design for the MTP® PRO employs a rotating metal pin keeper which is securely and automatically locked into place via use of the ferrule spring. Actuation of the specially designed tool is necessary to rotate the pin keeper when changing from pinned to unpinned.

No degradation in Pin Retention after 200 cycles!

MTP® PRO Guide Pin Pull Out Force		Competitive Guide Pin Pull Out Force	
Force (N)		Force (N)	
1	47.8	1	7.2
2	49.8	2	6.3
3	47.9	3	4.3
4	48.7	4	6.6

*IEC 61754-7 pin retention force: 19.6N Minimum



Field Polarity Change

Reliable One Step Polarity Change

The MTP® PRO polarity change feature offers a quick and efficient method for field configuration. One simple insertion into the polarity change port reverses the keying configuration by retracting the exposed key while simultaneously extracting a hidden key on the opposite side of the connector.

- No housing removal necessary
- Simple insertion into the polarity change port reverses polarity
- Both keys are permanently mounted into the MTP® PRO housing
- Keys are color coded to indicate field or factory setting



1. Black key from the factory setting is exposed



2. Insertion of MTP® PRO connector into tool reverses the key

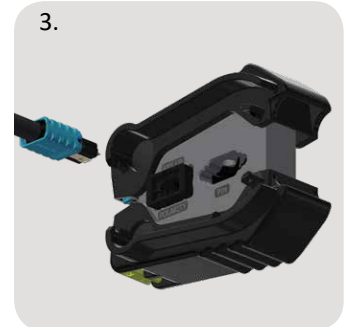

3. After removal from tool, the black key is retracted and the white key is exposed

Why Change Polarity? Isn't polarity standardized?

'Standardized' Polarity for array fiber connectors is a bit of a misnomer. TIA has established multiple methods for managing duplex Tx/Rx devices with single row multi-fiber trunk cables and some of those methods include varying provisions on how to manage polarity for multi-channel Tx/Rx links. Furthermore proprietary variants exist from structured cabling companies. The end result is a plethora of cable and adapter types in the field driving a need for simple field configurability.

MTP® PRO Field Configurable Polarity Convention



Black key exposed corresponds to factory polarity setting

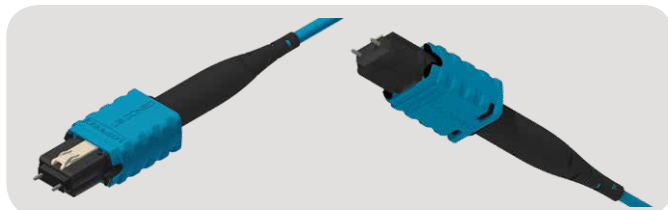

White key exposed corresponds to field polarity setting

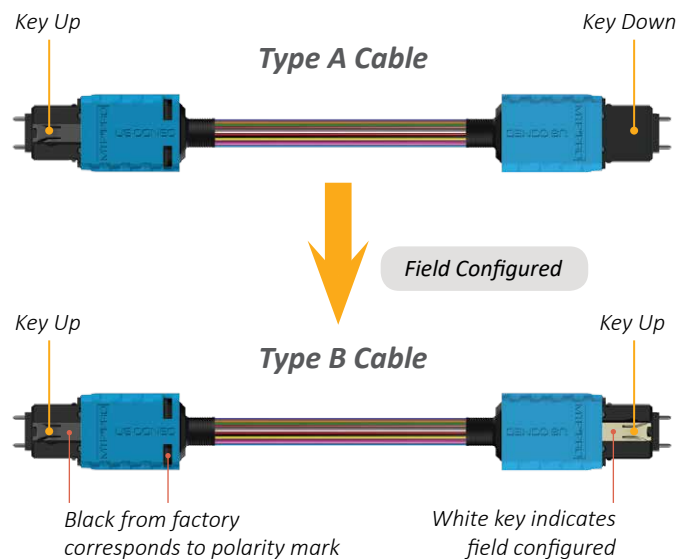

Logistical Simplification

With multiple standardized and non-standardized methods for maintaining polarity in MPO-based structured cabling, an endless number of scenarios may be encountered in the field. Field configurable polarity saves time, eliminates costly errors, requires less pre-planning and reduces cabling inventory resulting in a total lower cost cabling infrastructure.

TIA Polarity Examples

Alternate polarity methods are employed for the same QSFP link types:

Method A

Method A per TIA 568 requires ≥ 1 Type A cable(s) and 1 (and only one) type B cable. Effective book keeping is required to ensure which cable type is needed for expansion, moves, etc.

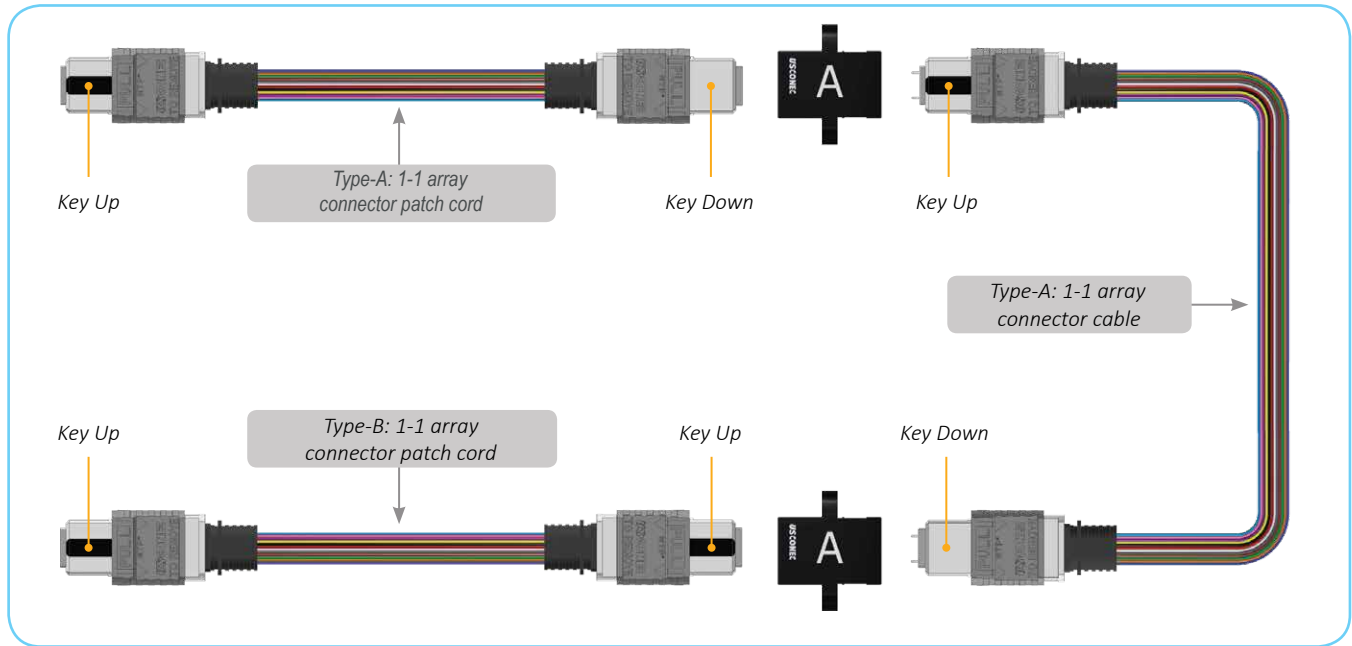

Method B

Method B per TIA 568 utilizes only Type B cables. Type A cables cannot be employed into a Method B installation.

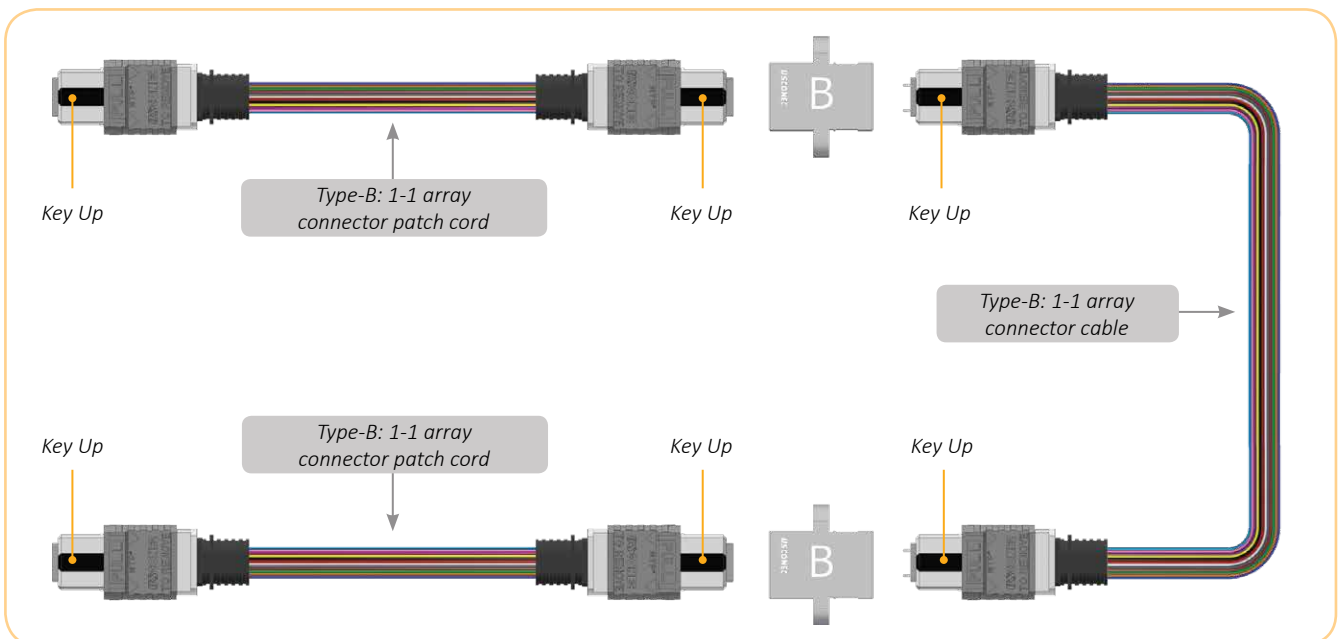

Debris Reduction

Reduced Debris, Better Performance

Debris impacts fiber optic connector performance in multiple ways. The less susceptible to generating debris through repeated matings, the less likely that debris will interfere with performance. The MTP® PRO connector has multiple enhancements which reduce debris generation:

- Latch lock geometry and material optimized to reduce insertion and extraction forces while minimizing adapter latch and housing wear
- Improved ferrule true position within the MTP® PRO housing for optimal course alignment between pin and guide pin hole
- MTP® PRO housing to adapter fits far exceed requirements of TIA FOCIS 5 and IEC 61754-7
- New non-debris generating dissipative dust cap
- Includes existing MTP® brand patented elliptical guide pin geometry

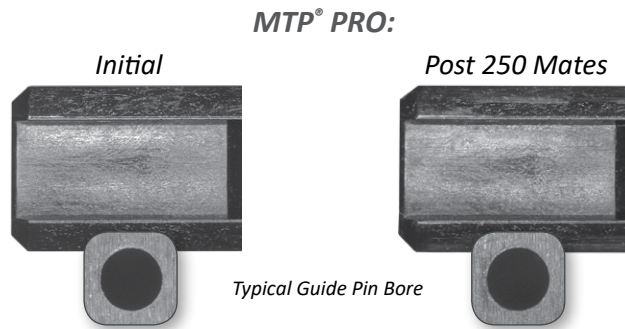

Debris can result in link failure in MPO cables for a variety of reasons:

- Occlusion of light when particles migrate to the fiber core
- Loss of physical contact of the polished ferrules and therefore fiber tips due to particles on the endface of the ferrule away from the fiber tips
- Loss of physical contact of the fiber tips when debris in guide pin bores causes friction between pin and ferrule
- Damage to fiber tips or ferrules due to mating a contaminated pair

Lasting Effects of Contamination:



Cleanliness from the Factory to Field

The all new MTP® PRO Dust Cap is designed to ensure high quality cables perform in the field on the initial insertion as they did during final quality control in the factory:

- Static dissipative material minimizes triboelectric charging effects
- Non-debris generating material over repeated uses
- No stress in the part in the mated state ensures no retention degradation over time
- Novel design encapsulates push-pull sleeve
- Optional lanyard attachment

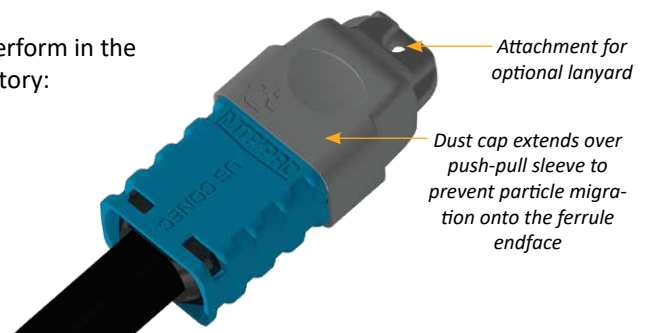

Simplified Use: Easy insertion and extraction

The push-pull functionality of the traditional MPO format requires the installer to push on the strain relief portion of the connector for insertion while extracting the connector by pulling on the often hard to reach external sleeve.

The MTP® PRO design simplifies this action by re-inventing the insertion function of the MPO format such that the external sleeve of the connector can be used for insertion in addition to the normal extraction as is the natural tendency of the installer. The MTP® PRO push-pull sleeve has an increased length, making it easier to access without compromising connector footprint. In addition, the MTP® PRO push-pull boot provides even easier access to mate and un-mate the connector in extremely dense applications.



- Simply push on the sleeve or push-pull boot for insertion
- Pull on the sleeve or push-pull boot for extraction
- Fully intermateable with standards compliant MPO adapters and plugs
- Reduced insertion and extract forces
- Polarity marks on push-pull sleeve correspond to factory key setting

Traditional MPO

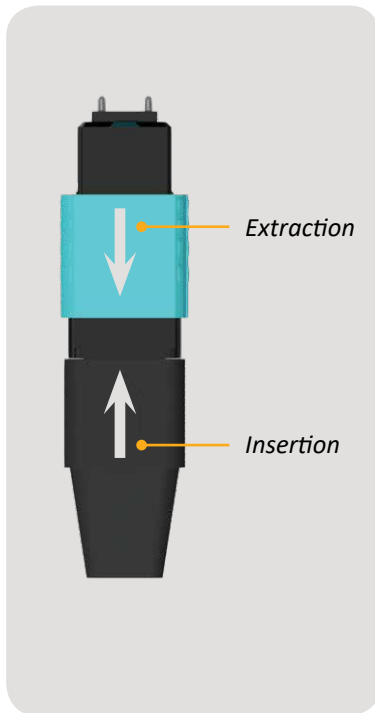

MTP® PRO

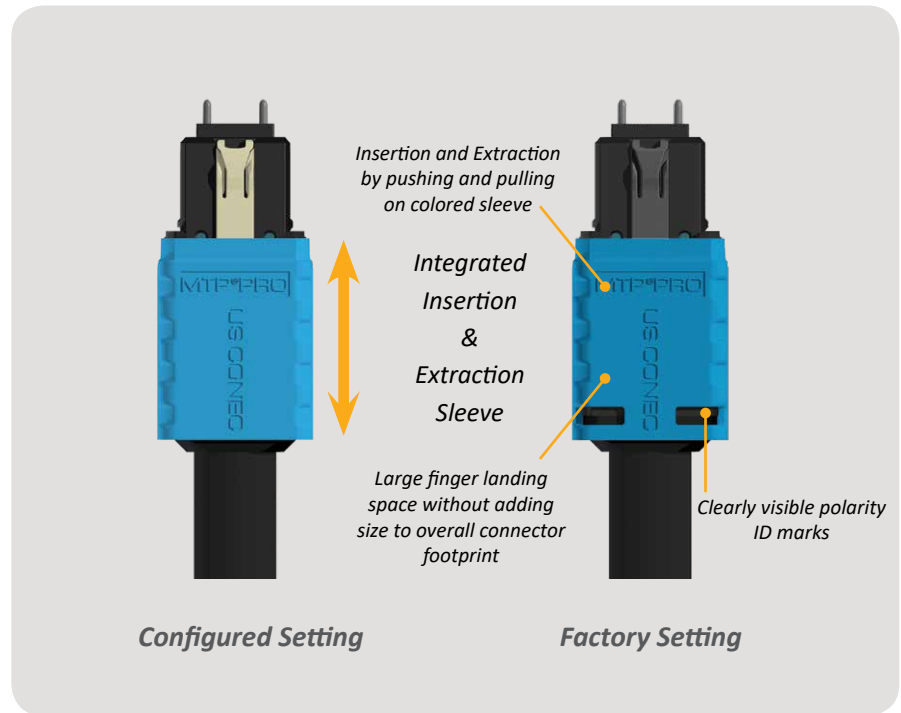

High Performance Optimized for a Greener World

US Conec strives in all aspects of our business to minimize our environmental impact by developing products and practices that are safe and sustainable. The MTP® PRO connector is designed to exceed industry relevant regulatory requirements.

Dedicated to continual improvement in our environmental initiatives, we monitor current global environmental legislation activities to ensure our products are aligned with and adhere to the latest regulations.

- RoHS and REACH compliant without exemptions
- Environmental and people friendly

