



PATCHBOX

Product Brochure

patchbox.com

shop.patchbox.com

About the company.

Our company was founded by Alexander Geng and Josef Hofstätter in 2015 with the goal to simplify and accelerate the everyday life of network management. Inventor & Co-Founder Alexander Geng is a former IT technician who has firsthand knowledge of the challenges and consequences of the industry's problems.



Alexander Geng



Josef Hofstätter

Trusted by global brands from every industry.

Since our establishment in 2015, we have been recognized with multiple awards for our products. We are proud to have revolutionized the IT infrastructure of over 30,000 customers from every industry and some of the world's biggest brands, including McDonald's, Amazon, Microsoft, Hilton Hotels, Walt Disney Parks and Resorts, and many more.

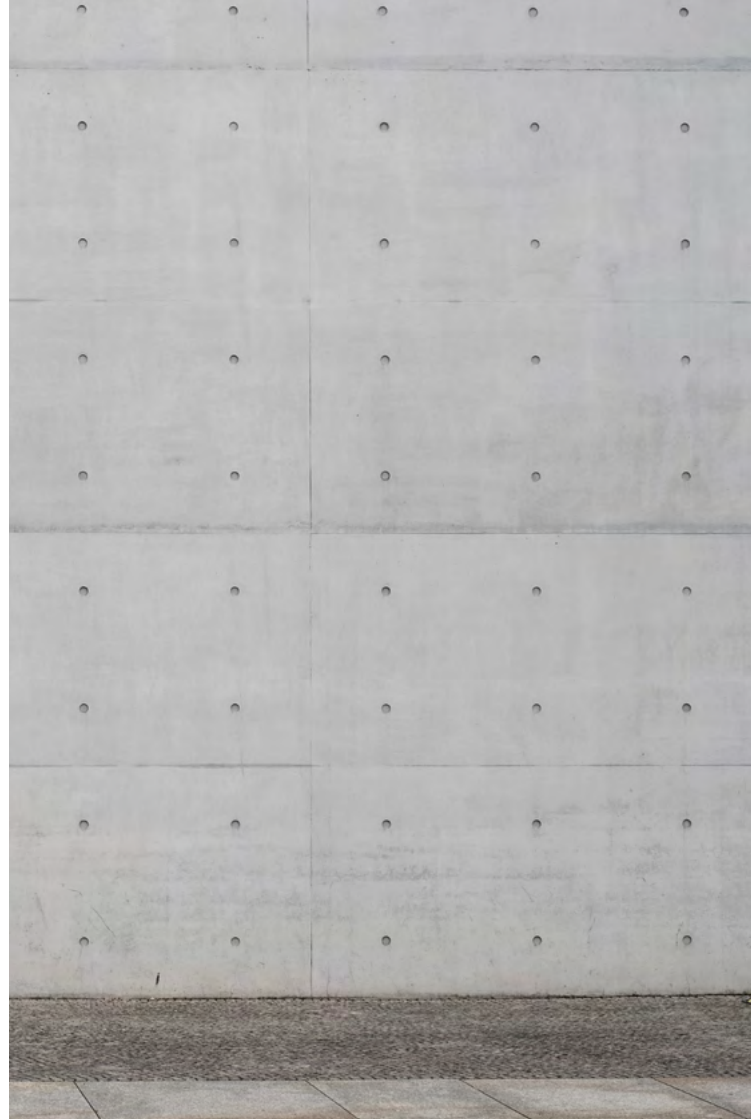

Hilton

WALT DISNEY
Parks and Resorts

mondi

amazon

HITACHI
Inspire the Next

DECATHLON



T Mobile

SCHIEBEL



Microsoft

SIEMENS



Staatsoper
Hamburg

eppendorf

Continental



Table of Content

PATCHBOX

8–9

patchbox.one

10–17

Frame

18–19

Cassettes

20–21

Cables

22–23

Accessories

24–25

Setup.exe

26–29

/dev/mount

30–31

Shop our products on
patchbox.com



PATCHBOX
Simplify IT

Simplify your IT. With PATCHBOX.

IT is the heart of every company. Disruptions within IT can have far-reaching consequences, such as costly downtimes that can bring an entire company or production to a standstill.

We at PATCHBOX want to make IT more efficient, more reliable and easier with our products - from hardware installation to cable management and device mounting.

The Art of Network Cabling

Our patchbox.one is the most innovative cable management system for network racks and a long-term solution to costly and underestimated problems. With its retractable cables, the patchbox.one helped thousands of customers worldwide to optimize, scale up and standardize their IT, making it efficient, faster and more economical. Choose from a pre-configured patchbox.one or create your own.



See the patchbox.one in action

Scan the QR code or visit
patchbox.com/patchbox



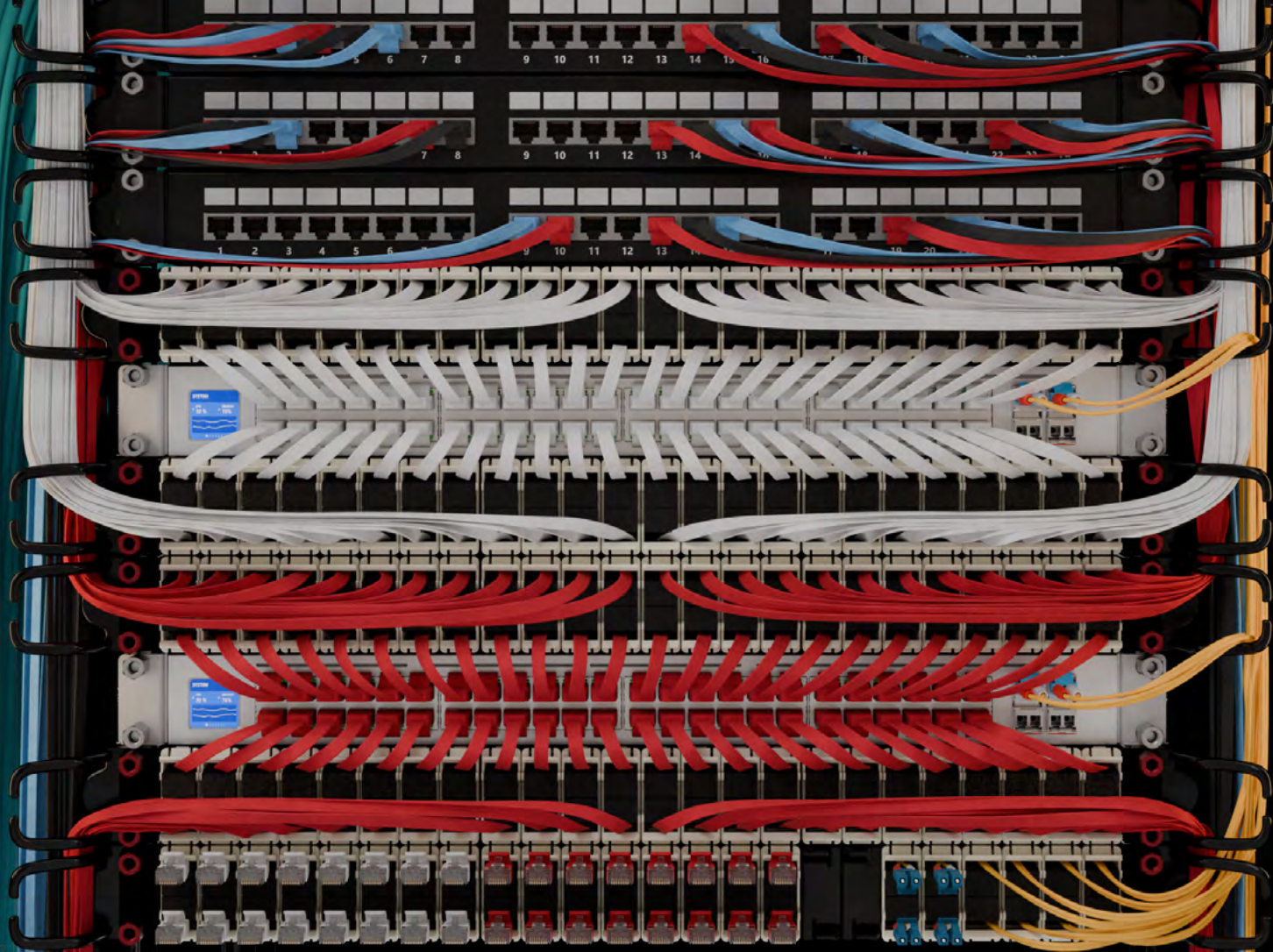



Replacing a Switch has never been quicker.

patchbox.one enables faster replacement of a defective switch and quicker maintenance. This keeps maintenance and server downtime short and costs low.



Shorter Downtimes

The patchbox.one can shorten the duration of downtimes by up to 90%



10-Year Warranty

patchbox.one & its cables are covered by a 10-year warranty



Up to 50% more space

In comparison to conventional cabling up to 50% more rack space



Up to 10x faster

Maintenance, as well as installation is up to ten times faster

Conventional Cabling

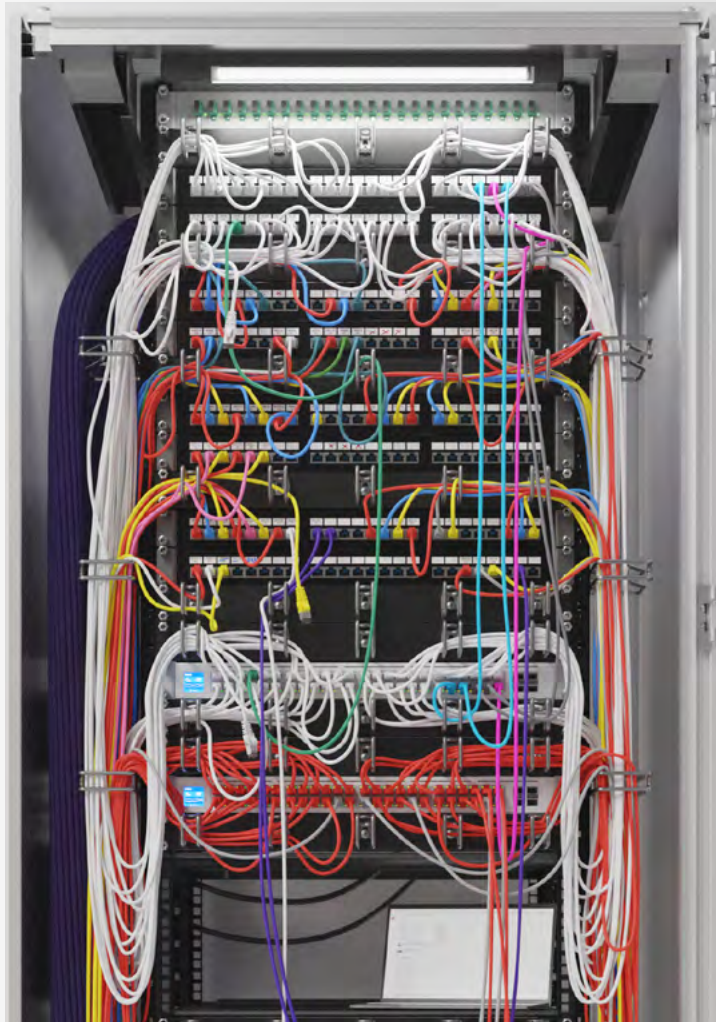

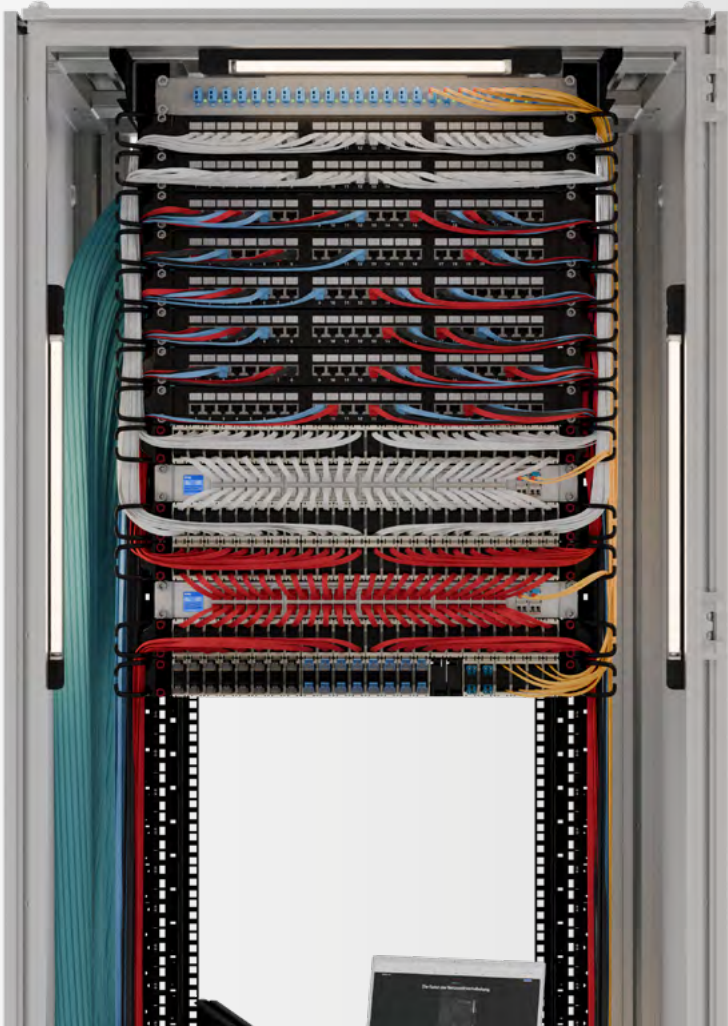

Technical details

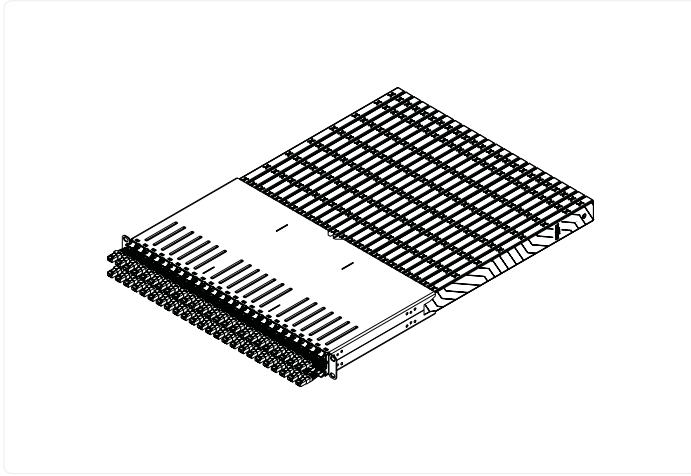

patchbox.one / 30RU / Cat.6a

STP Cable

Flat Cat.6a U/FTP, ISO/IEC 11801 Channel Class Ea, ANSI/EIA/TIA-568 Cat 6A Channel, 500MHz, AWG36, 100% stranded copper, PVC jacket, PoE (802.3af), RoHS compliant

UTP Cable

Flat Cat.6a U/UTP, ISO/IEC 11801 Channel Class Ea, ANSI/EIA/TIA-568 Cat 6A Channel, 500MHz, AWG30, 100% stranded copper, PVC jacket, PoE++ (802.3bt, Type 3 (60 W)), RoHS compliant

Connector Cat.6a

RJ45 shielded plug, pins gold plated, snagless booted

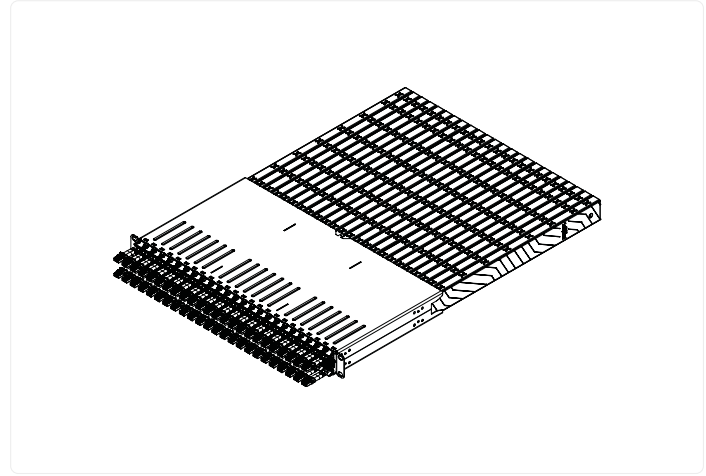

patchbox.one / 30RU / Fiber Optic

OS2 Cable

OS2 RBS 9 μ /125 μ , G.657.B3, LSZH, Yellow, Single-Mode, RoHS compliant

OM4 Cable

OM4 RBS 50 μ /125 μ , LSZH, Erika Violet, Multi-Mode, RoHS compliant

Connector Fiber Optic

LC Duplex – LC Duplex / LC Duplex – SC Duplex

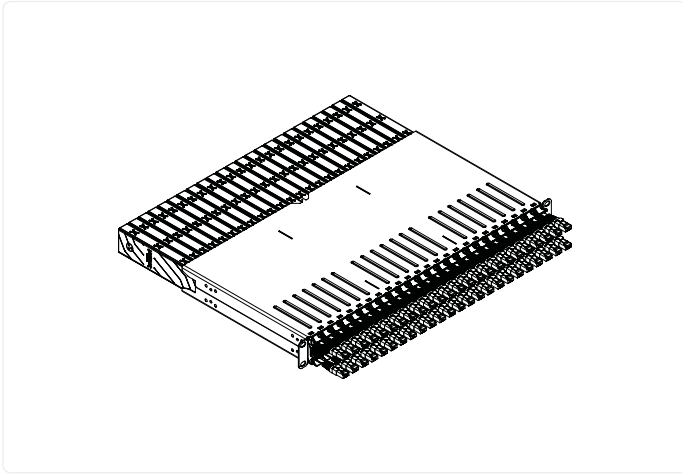

patchbox.one / 8RU / Cat.6a

STP Cable

Flat Cat.6a U/FTP, ISO/IEC 11801 Channel Class Ea, ANSI/EIA/TIA-568 Cat 6A Channel, 500MHz, AWG36, 100% stranded copper, PVC jacket, PoE (802.3af), RoHS compliant

UTP Cable

Flat Cat.6a U/UTP, ISO/IEC 11801 Channel Class Ea, ANSI/EIA/TIA-568 Cat 6A Channel, 500MHz, AWG30, 100% stranded copper, PVC jacket, PoE++ (802.3bt, Type 3 (60 W)), RoHS compliant

Connector Cat.6a

RJ45 shielded plug, pins gold plated, snagless booted

Items included patchbox.one / 30RU

- 24 x Cassettes with Patch Cords
- 1 x patchbox.one / Frame
- 2 x Mounting rails
- 4 x Hex nuts
- 4 x Flanges
- 6 x Patchcatch

Items included patchbox.one / 8RU

- 24 x Cassettes with Patch Cords
- 1 x patchbox.one / Frame
- 2 x /dev/mount
- 4x Hex nuts
- 6 x Patchcatch

Available Colors for Cat.6a Cables



Full Technical Specifications

Scan the QR code or visit
patchbox.one/tech-specs

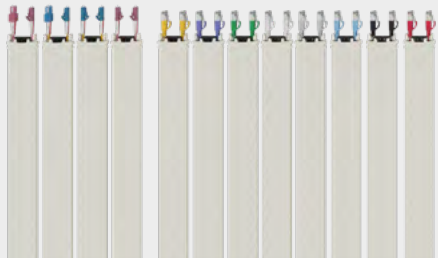

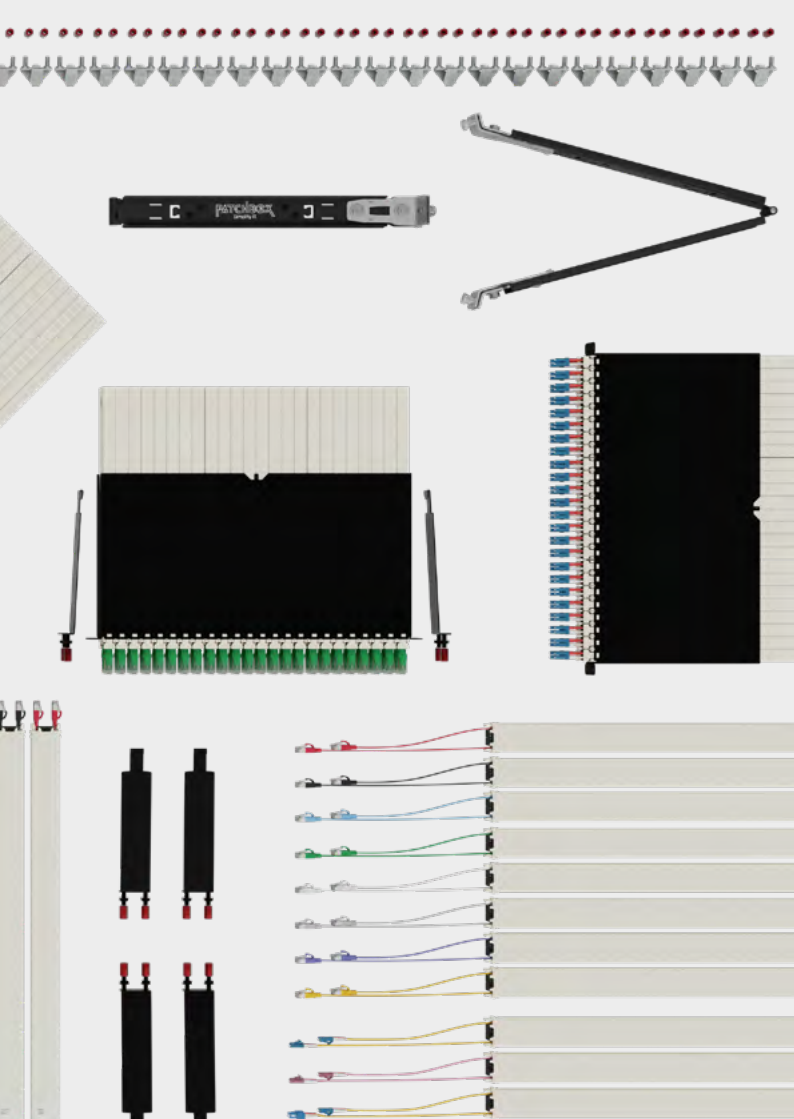

**Fully Modular.
Built to meet your
requirements.**

patchbox.one / Frame

Want to create your own patchbox.one? The Frame offers space for 24 Cable Cassettes. We offer a big variety of cable types, colours and connectors. The new patchbox.one Cassettes, as well as its predecessor's Cassettes (Plus+ and 365), are compatible with the Frame.

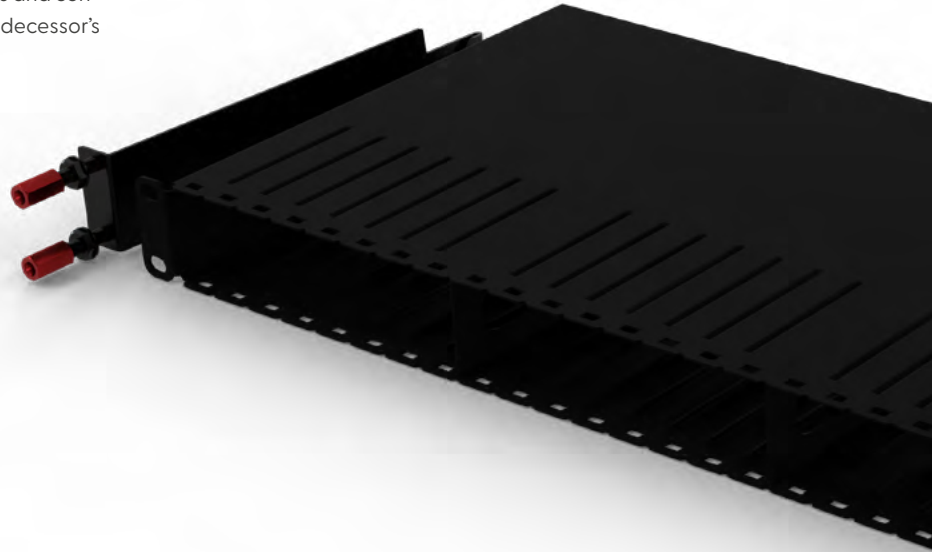

See the patchbox.one in action

Scan the QR code or visit
patchbox.com/patchbox

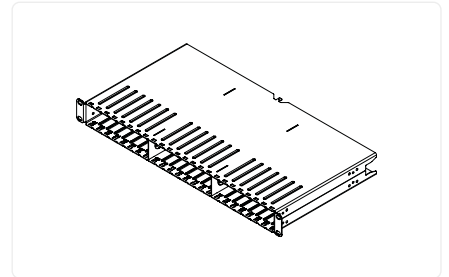
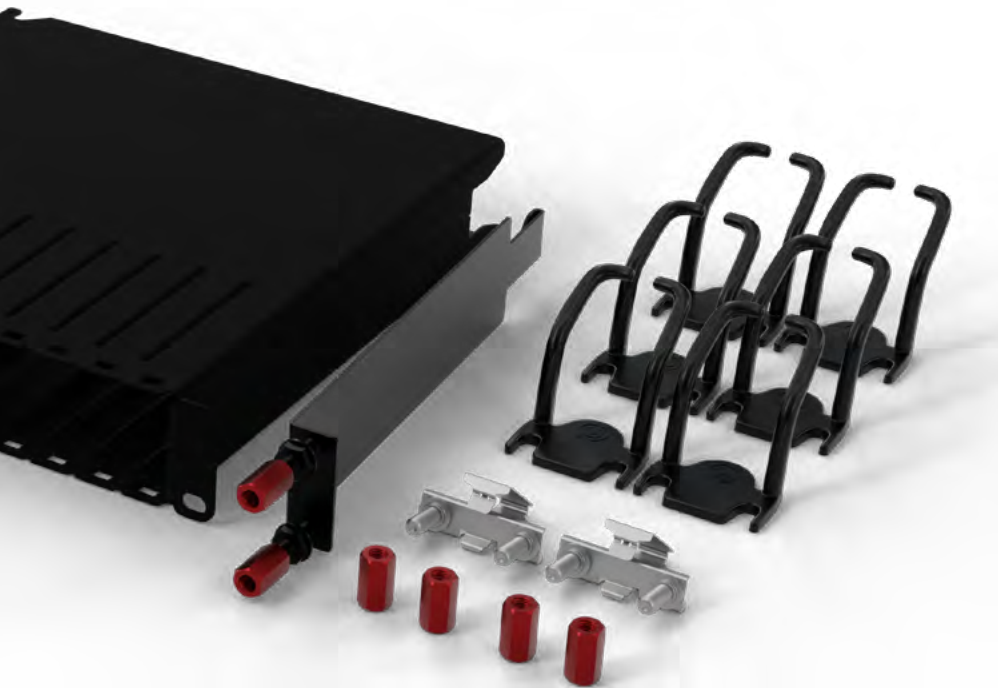

Frame

RAL9005 powder coated steel

Plastic Parts

Polyoxymethylene POM

Gross Weight

2.65 kg / 5,84 lbs

Mounting Rails

Steel and RAL9005

Items included

- 1 x patchbox.one / Frame
- 2 x Mounting rails
- 2 x /dev/mount
- 4 x Flanges
- 8 x Hex nuts
- 6 x Patchcatch

patchbox.one / Cassettes

Within each Cassette is our patented pulley mechanism that retracts the cable, and the cable stoppers, with which you can adjust it to your desired length.

Benefit from the interchangeable and modular system of the patchbox.one. Swap Cable Cassettes easily within seconds and have the patchbox.one as you need it. Thanks to backward compatibility, the new and the old cassettes (Plus+ and 365) can be used in the Frames.

covers 46RU

covers 30RU

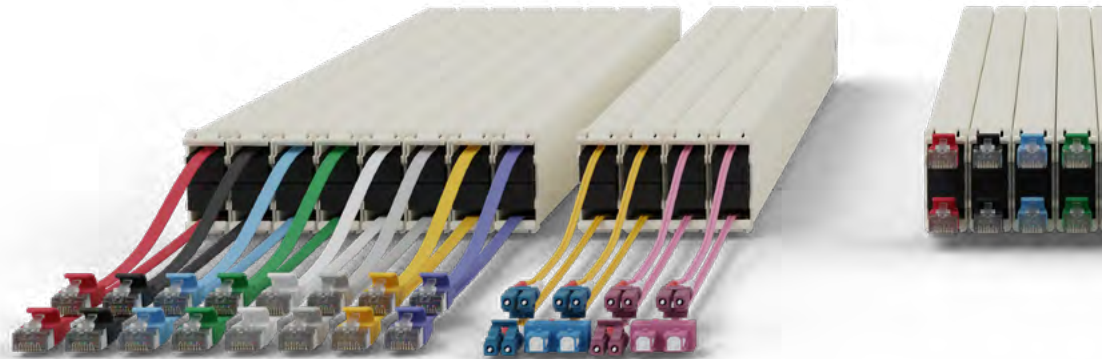

See the patchbox.one in action.

Scan the QR code or visit
patchbox.com/patchbox



Power over Ethernet

Power your devices with PoE (STP: PoE / UTP: PoE++ Type 3).



Patented Pulley Mechanism

Stores the excess length of the patch cables in the cassette.



Cable Colors

Allows you to visually separate different applications from each other.



10-Year Warranty

patchbox.one & its cables are covered by a 10-year warranty.

patchbox.one / Cassette / 8RU

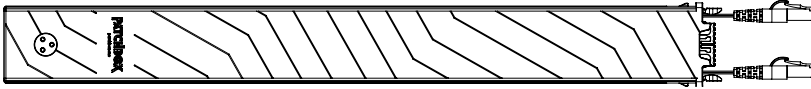

Available as: Cat.6a (STP / UTP) and Fiber Optic (OS2 / OM4)

Installation depth: 365 mm / 14.37 in

Patchable length: 0.8 m / 2.6 ft - covers 8RU from mid to mid

patchbox.one / Cassette / 30RU

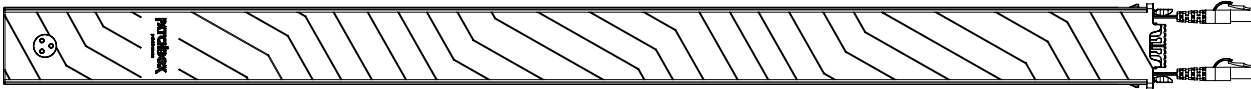

Available as: Cat.6a (STP / UTP) and Fiber Optic (OS2 / OM4)

Installation depth: 600 mm / 23.62 in

Patchable length: 1.8 m / 6 ft - covers 30RU from mid to mid

patchbox.one / Cassette / 46RU

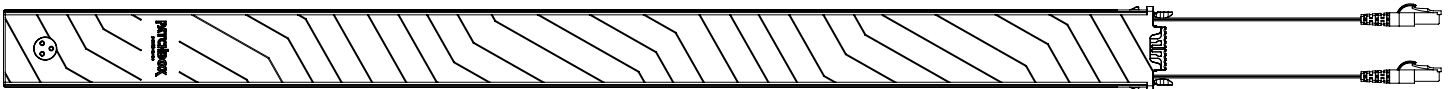

Available as: Cat.6a (STP / UTP) and Fiber Optic (OS2 / OM4)

Installation depth: 600 mm (23.62 in)

Patchable length: 2.5 m / 8.2 ft - covers 46RU from mid to mid*

* 0.7 m / 2.3 ft overlength non-retractable and hangs out of the Cassette when unpatched.

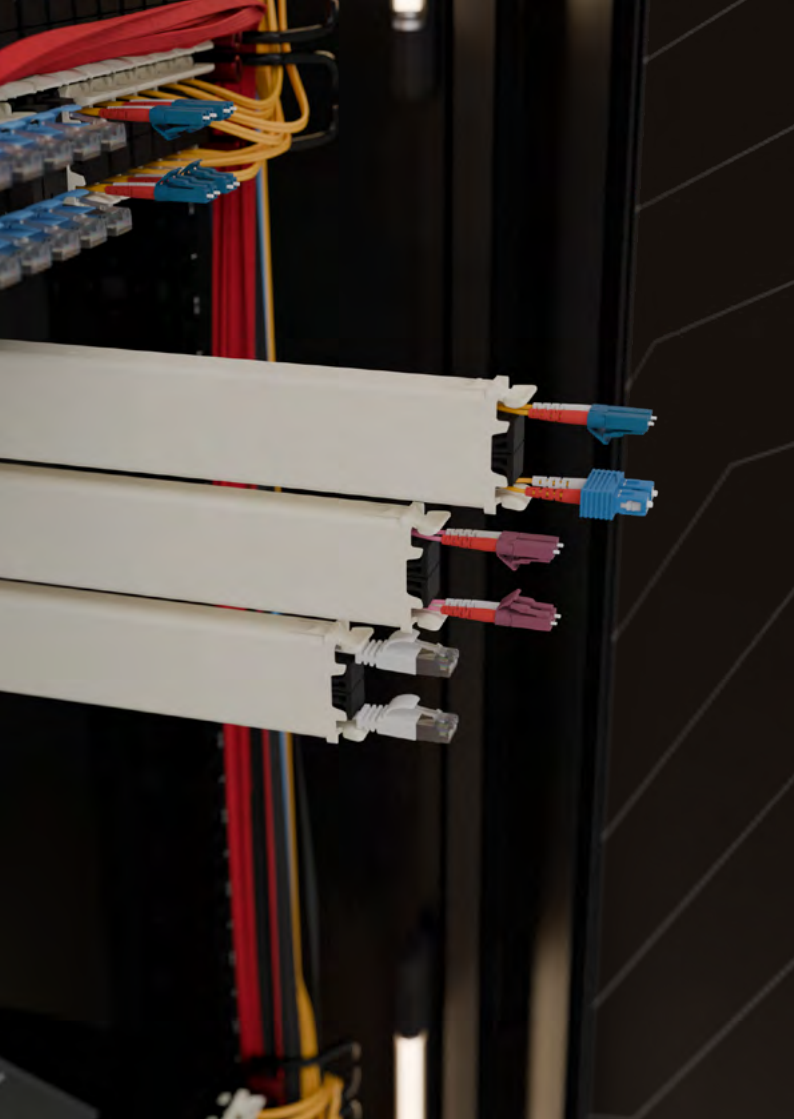

Bend-insensitive Cat.6a & Fiber Optic

Cat.6a

Our flat and twisted Cat.6a cables are tested to ISO/IEC 11801 Channel Class Ea and ANSI/EIA/TIA-568 Cat 6A Channel standards. They are lighter than round cables, which means less weight and tension on the cables and ports. The flat cables are also easier to bend and take up less space in the rack. They are available as UTP and STP and in eight different colors: black, white, red, green, blue, yellow, grey and violet.

Fiber Optic

You want more speed? Our patchbox.one is also available with Fiber Optic cables. They are made with ClearCurve® Fibers from Corning®, the most bend-insensitive fibers on the Market. Choose from OS2 or OM4 (100 Gbps) and LC-LC or LC-SC connectors – as well as many other connectors on request.

patchbox.one / Accessories



Get even more out of your network rack and your patchbox.one with our accessories. You want to save even more space in your rack? You want to cover unused slots? Turn to the next page to learn more.



Technical Specifications

Scan the QR code or visit
patchbox.one/accessories/tech-specs

patchbox.one / Patchcatch

The Patchcatch included with every patchbox.one is a must-have for your network rack. Unlike conventional cable managers, it does not waste rack units. It helps you guide cables more intuitively and efficiently, keeping the cable in the correct rack units. This enables a better overview and prevents tangled cables. Thanks to our space-saving Patchcatch, you can use up to 50% more space in your rack.

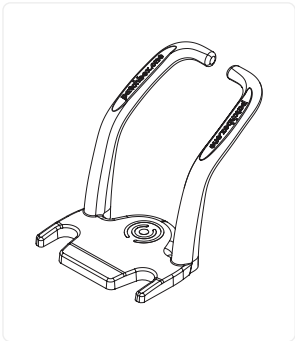



patchbox.one / Blind Panels

The Blind Panels can be used to cover up unused slots from your patchbox.one. This ensures air circulation within your cabinet remains optimised and keeps cool what needs to be kept cool. Simply clip them into the frame and reuse them anytime in another slot.

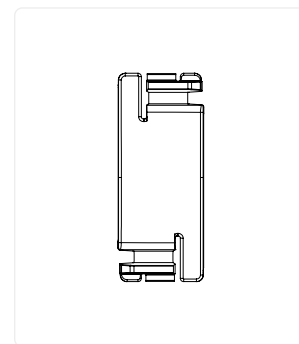

Setup.exe

The Ultimate Tool for Network Racks



See the Setup.exe in action
Scan the QR code or visit
patchbox.com/setup-exe

The Setup.exe is our innovative hardware installation tool for your network rack. It allows you to mount hardware faster and easier without getting into uncomfortable or risky positions. And with its spring-loaded pins, it is mounted within seconds.



For heavy-duty.

Crafted from stainless steel & aluminum as used in satellites. Our Setup.exe can hold up to 50kg/110lbs. Whether you're configuring a switch or terminating a patch panel, it provides a safe and convenient workspace that makes work in the network rack easier and more efficient.



Max. load weight

50 kg / 110 lbs

Gross Weight

1.03 kg / 2.27 lbs

Items included

- 1 x Setup.exe
- 1 x Threaded holes adapter
- 1 x Squared holes adapter





Holds your heavy hardware

Carries your heavy switch or your precious laptop.



Safer to work with

Installation is way easier, more comfortable and back-friendly.



19" Rack Hercules

Carries components with up to 50kg (110lbs).



Lifetime warranty

You will only need one Setup.exe in your lifetime. Trust us.

/dev/mount

The fastest way to mount hardware.



See the `/dev/mount` in action.
Scan the QR code or visit
patchbox.com/dev-mount

The /dev/mount is our awarded cage nut alternative. Made in Germany from spring steel and aluminium, it enables easy, fast & pain-free hardware mounting – without the use of any tools. It is quickly snapped into the rack and tightened by hand.



The Easy-To-Install Solution

The /dev/mount doesn't require tools and fastening hardware is up to 3x faster than with conventional cage nuts. The snap-in system ensures a swift and effortless mounting experience, saving valuable time.

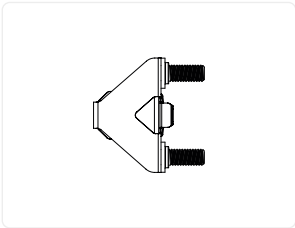

Compatibility.

Suitable for 19" rails with square punched holes, which can be used to install standard server rails.

Items included

50 x /dev/mount
100 x Hex nuts





Toolless

No tools are needed. Easily fasten per hand.



Strong

Made out of high-quality spring steel and aluminum.



Up to 3x faster

Fastening hardware is up to 3x faster than with cage nuts.



Awarded

Awarded Platinum and excellently rated with 4,94/5 stars.

shop.patchbox.com

Further product information as well as prices can be found in our online-shop shop.patchbox.com. If you prefer or need an official Quote from us, you can request one under patchbox.com/products



People
love us





PATCHBOX GmbH
Handelskai 94-96/271
1200 Vienna / Austria

sales@patchbox.com
+43 1 99 71 960

patchbox.com
shop.patchbox.com
