

## 10" SINGLE WALLMOUNT CABINET

WCAB 10 312X300X6U

### DESCRIPTION

- Wirewin® 10" single section Wallmount Cabinet
- Glasdoor, lockable
- 2 pairs 10" mounting Rails
- Top case integrated with a brushed cable entry point with w:145mm x d:70mm size allows proper cabling insertion as
- Bottom case integrated with a PVC Gland plate w:145mmxd:70mm. well preventing the dust entry.
- 312 mm width
- 300 mm depth
- 6U / 9U heights
- tested with 20 kg load



### Specifications:

Material:	<ul style="list-style-type: none"> <li>• Main Body (Structure): DIN EN 10130-DC-01-6112 CRS, 0,8 mm</li> <li>• Front Door: EN 12150-1 Tempered Secure Glas, 4,0 mm</li> <li>• 19" Equipment Mounting Rails: DIN EN 10130-DC-01-6112 CRS, 1,2 mm</li> <li>• Rear Body Frame: DIN EN 10130-DC-01-6112 CRS, 1,0 mm</li> <li>• Side Panels: DIN EN 10130-DC-01-6112 CRS, 0,8 mm</li> </ul>
Colour:	<ul style="list-style-type: none"> <li>• RAL7035, Light Grey</li> </ul>
max. Load:	<ul style="list-style-type: none"> <li>• 20 kg load tested</li> </ul>
Packaging:	<ul style="list-style-type: none"> <li>• single, carton packaging</li> </ul>

### COLOR: RAL7035, LIGHT GREY

UNITS	PART NUMBER	WIDTH	DEPTH	HEIGHT	WEIGHT	EAN NUMBER	PACKING BOX SIZE
6U	WCAB 10 312X300X6U	312	300	330	5,50	9120072488764	355x340x365
9U	WCAB 10 312X300X9U	312	300	464	6,50	9120072488207	355x340x500

10" SINGLE WALLMOUNT CABINET

WCAB 10 312X300X6U

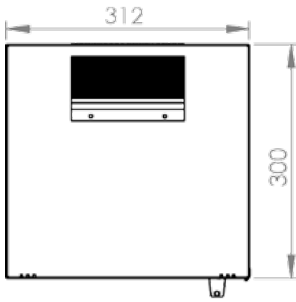

Top view

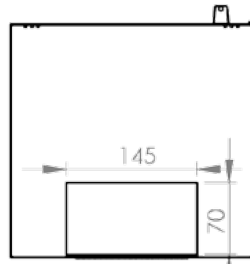

Bottom view

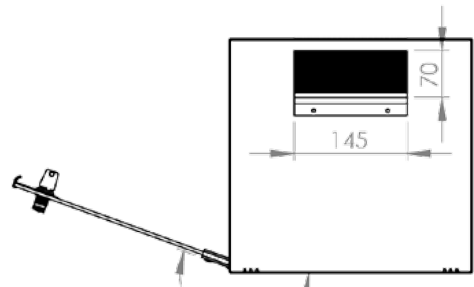

0°-200° Front door opening angle

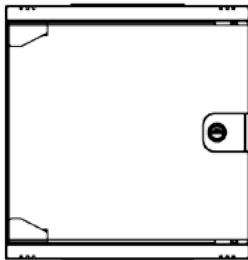

Front view

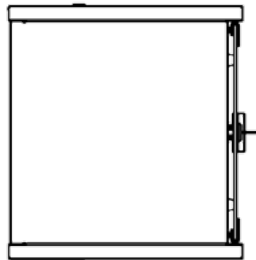

Side view

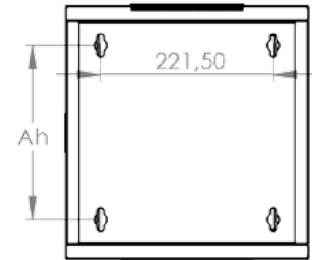

Rear view

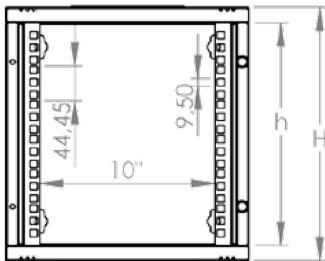

Dimension in width and height

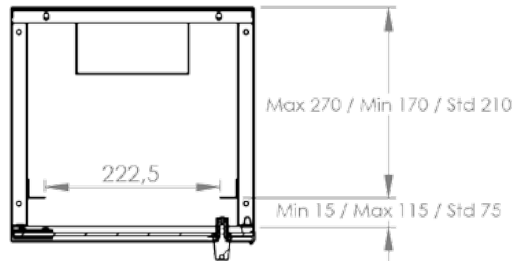

Max/Std/Min equipment mounting distance

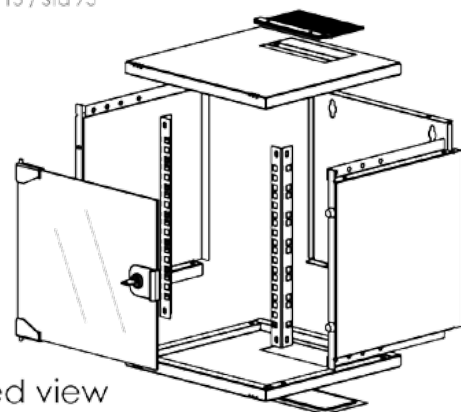

Exploded view